

**NATIONAL
LIGHTING
PRODUCT
INFORMATION
PROGRAM**

Specifier Reports

HID Accent Lighting Systems

Low-wattage high-pressure sodium and metal halide lamps and accent luminaires

Volume 4 Number 2

October 1996

Program Sponsors

- CINergy
- Energy Center of Wisconsin
- Iowa Energy Center
- Lighting Research Center
- New England Electric Companies*
- New York State Energy Research and Development Authority
- Northern States Power Company
- Southern California Edison Company
- United States Department of Energy
- United States Environmental Protection Agency

* The New England Electric Companies include New England Power Service Company, New England Power Company, Massachusetts Electric Company, The Narragansett Electric Company, and Granite State Electric Company.

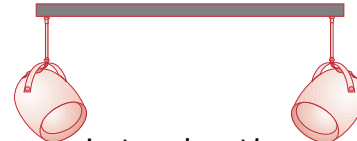

Introduction

Low-wattage high-pressure sodium (HPS) and metal halide (MH) lamps are increasingly popular among lighting specifiers (see Figure 1). These high-intensity discharge (HID) lamps are rated at 175 watts (W), have higher efficacy, longer average rated life, and greater light output than the incandescent lamps typically used for accent lighting applications. Some low-wattage HID lamps also offer color properties comparable to those of incandescent sources. As a result, low-wattage HID systems can be used in applications that require efficacious sources with high intensities, good color rendering properties, and long life. However, because low-wattage HID systems are relatively new, specifiers and users may have questions about the performance of these systems in accent lighting applications. The electronic ballasts developed for some low-wattage HID lamps also add decisions in the specification process.

Figure 1. Low-Wattage HID Accent Lighting of a Grocery Store Floral Display



Contents

- Introduction 1
- Lamps 2
- Ballasts 6
- Luminaires 8
- Alternative Technologies 13
- Performance Evaluations 13
- Further Information 15
- Data Table Terms & Definitions 16
- List of Tables 18
- Publication Ordering Information 48

from DELTA Portfolio, Vol.1 No.1

Findings

- With a few exceptions, low-wattage HID lamps meet their manufacturer-reported ratings.
- Tilting universal-burn MH lamps has little effect on their light output.
- Electronic ballasts for double-ended MH lamps provide more consistent lamp performance over variations in supply voltage than magnetic ballasts do.

In this issue of *Specifier Reports*, the National Lighting Product Information Program (NLPIP) evaluates the following characteristics of HID accent lighting systems:

- Photometric performance of low-wattage HID lamps from six manufacturers.
- Effects of tilting on the light output of medium-base, universal-burn MH lamps.
- Effects of voltage variation on the light output, color, and lamp power of double-ended MH lamps from four manufacturers, operated on electronic and magnetic ballasts.
- Ease of aiming and relamping of recessed and semi-recessed adjustable luminaires and track luminaires from seven manufacturers.



Lamps

Specifiers have used incandescent reflector (R) and parabolic aluminized reflector (PAR) lamps to illuminate displays and merchandise because of their color properties and their diversity of size, beam intensity, and beam spread. Compared to existing HID lamps, these incandescent lamps were relatively expensive to operate because of their relatively short lives and low efficacies. Conversely, HID lamps offered long average rated life and high efficacies but were too large and produced too much light to be effective in accent lighting systems. New low-wattage HID lamps offer much longer life and better efficacy than incandescent lamps, and their color rendering characteristics approach those of incandescent lamps. These new HID lamps also are available in compact sizes. Luminaires for these low-wattage HID lamps frequently are similar in size

and appearance to luminaires for incandescent lamps.

Low-wattage HID lamps are also alternatives for incandescent reflector lamps that do not meet the lamp efficacy requirements of the Energy Policy Act of 1992 (EPACT) (U.S. Congress 1992). State energy codes that establish power limits for lighting, usually based on ASHRAE/IES Standard 90.1, are also more easily met with HID systems than with incandescent systems. Although lamp manufacturers offer incandescent reflector lamps that do meet EPACT requirements (see NLPIP's *Specifier Reports: Reflector Lamps*), the efficacies of these lamps are still significantly lower than those of low-wattage HID lamps.

Table 1 on p. 19 lists the manufacturers of HID lamps and their telephone numbers. Tables 2–4 on pp. 20–29 list manufacturer-reported information for many of the lamp characteristics described in this report. Information about NLPIP's evaluation of HID lamps is available in "Lamp Evaluations" on p. 13. The results of the evaluations appear in Tables 5 and 6 on pp. 30–31.

Operation and Construction

HID lamps start when a high voltage [3–5 kilovolts (kV)] is applied to the electrodes through a gas mixture in a discharge (arc) tube. The discharge tube of an MH lamp contains mercury and halide compounds and usually is made of quartz, although ceramic is sometimes used (see sidebar "Ceramic Discharge Tubes for MH Lamps" on p. 3). The discharge tube of an HPS lamp contains mercury, sodium amalgam, and xenon, and it is made of ceramic which resists the corrosive sodium environment better than quartz. A ballast supplies the starting voltage that strikes an arc within the discharge tube of an HID lamp.

As pressure and temperature increase, the materials within the discharge tube vaporize and emit light and ultraviolet (UV) energy. A bulb, usually made of borosilicate glass, provides a stable thermal environment for the discharge tube and reduces the amount of UV radiation that the lamp emits. MH lamps often have a phosphor finish on the inside of the bulb that both diffuses the light and

Comparison of 100-W PAR Lamps

	Incandescent Flood	Metal Halide Flood	Incandescent Spot	Metal Halide Spot
CBCP (cd)	2,400	15,000	6,600	28,000
Initial Light Output (lm)	1,200	6,500	1,200	7,000
Average Rated Life (h)	2,000	7,500	2,000	7,500

Figure 2. Low-Wattage, Medium-Base ED17 MH Lamp

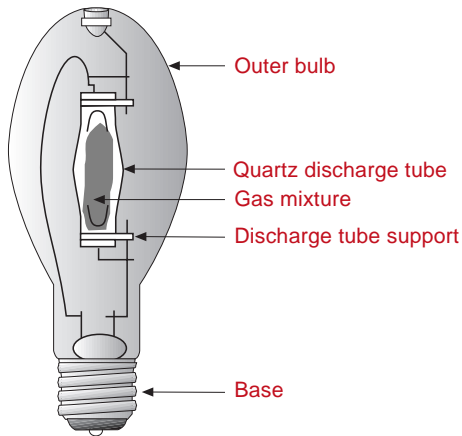
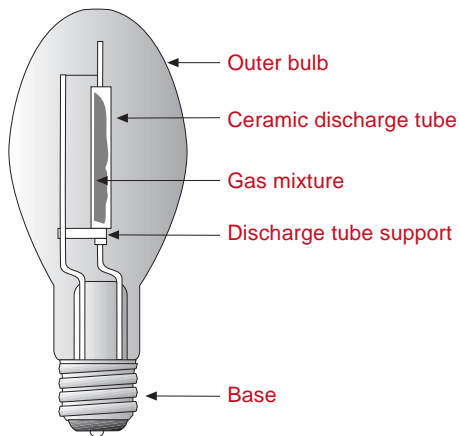

Figure 3. Low-Wattage, Medium-Base ED17 HPS Lamp



changes the lamp's color properties. HPS lamps sometimes have a diffuse finish, similar to that used in incandescent lamps, on the inside of the bulb to diffuse the light output. Figures 2 and 3 illustrate the construction of typical low-wattage, medium-base HID lamps.

With an appropriate ballast and control system, HID lamps with wattages as low as 100–150-W can be dimmed. See NLPIP's *Lighting Answers: Dimming Systems for High-Intensity Discharge Lamps* (1994).

Light Output

Ratings. Initial light output is the quantity of light in lumens (lm) produced by the lamp when it is new, usually after operating for 100 hours (h). Manufacturers report the light output of a lamp in its recommended operating position. For universal-burn lamps, some manufacturers report light output for both vertical and horizontal operating positions (see "Tilting" on p.4).

For PAR (parabolic aluminized reflector) lamps, manufacturers commonly provide the light intensity and beam spread instead of the initial light output. Manufacturers report the light intensity at the center of the beam as the center beam candlepower (CBCP) or the maximum beam candlepower (MBCP), measured in candelas (cd). The beam spread is described by the beam angle at which the lamp produces 50% of its CBCP, as shown in Figure 4. Lamp manufacturers provided the initial light output, CBCP, and beam angle for each of the MH PAR lamps included in this report; these values appear in Table 4 on p. 26.

In NLPIP's photometric measurements, most of the lamps equaled or exceeded their rated light output, although all of the MH PAR lamps had lower CBCP ratings in NLPIP's test than manufacturers reported.

Ceramic Discharge Tubes for MH Lamps

GE Lighting and Philips Lighting Co. have introduced MH lamps with ceramic discharge tubes. According to the manufacturers, ceramic discharge tubes offer 10 to 20% more light output, improve color stability and uniformity compared with MH lamps with quartz discharge tubes, and increase the color rendering index (CRI) value to more than 80 (see p. 5).

Figure 4. Beam Angle

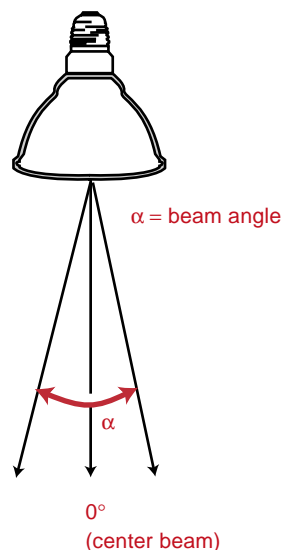

Tilting. In accent lighting systems, luminaires and lamps are often tilted so that their light output can be aimed. All low-wattage HPS and most medium-base low-wattage MH lamps are designed for universal operating positions. Manufacturers recommend that double-ended lamps be operated, and even stored, horizontally. Outside the specified operating range, which is available from the manufacturers, the light output of a low wattage MH lamp may decrease and its color appearance may shift.

NLPIP evaluated the effects of tilting on the light output of medium-base, universal-burn MH lamps and found insignificant changes in light output when lamps were tilted. See “Lamp Evaluations” on p. 13 for details about the evaluation.

Lamp lumen depreciation (LLD). LLD describes the gradual decrease in a lamp’s light output as the lamp ages. The primary cause of LLD in HID lamps is the evaporation of tungsten from the electrodes, which blackens the inside of the discharge tube. A secondary cause of LLD in MH lamps is degradation of the bulb’s phosphor finish, if it has one.

Manufacturers usually use a lumen maintenance curve to illustrate the decreasing light output of a lamp over its life. They also publish “mean lamp lumen” values, which indicate a lamp’s light output at a certain percentage of lamp life. Most manufacturers report mean light output for

HPS lamps at 50% of rated lamp life and for MH lamps at 40% of rated lamp life. According to manufacturer ratings, light output typically decreases by the percentages shown in the chart below. NLPIP did not measure LLD for this report.

Lamp Lumen Depreciation Over Time

Lamp Type	CRI	Decrease at 50% of Rated Lamp Life	Decrease at 40% of Rated Lamp Life
HPS	60–69	10–20%	NA
HPS	≥70	20–25%	NA
MH medium base	all	NA	15–40%
MH double ended	all	NA	10–20%

Efficacy

Efficacy is the initial light output of a lamp divided by its active power, expressed in lumens per watt (LPW). Lamp efficacy values listed in Tables 2–4 on pp. 20–29 include only the active power of the lamp and do not include ballast power. Low-wattage HPS lamps have efficacies between 40–73 LPW. Low-wattage MH PAR lamps range in efficacy from 46–70 LPW. Other low-wattage MH lamps range in efficacy from 60–95 LPW.

Safety Precautions for MH Lamps

MH lamps operate at very high pressures and may burst when they are operated outside normal electrical and thermal parameters or are near the end of their life. As a safety precaution, Underwriters Laboratory (UL) Standard 1572-1990 requires that luminaires that use MH lamps have a lamp containment barrier to prevent injury from broken lamps (UL 1990). Luminaires that have a lamp containment barrier are referred to as enclosed luminaires; those without such a barrier are referred to as open luminaires. A lamp containment barrier is not required if the lamp manufacturer specifies that the lamp can be used in open luminaires, or if the major axis of the lamp is oriented $\pm 15^\circ$ from vertical when the luminaire is installed as intended (UL 1990).

Some low-wattage MH lamps can be used in open luminaires. These lamps have a glass shroud inside the outer bulb that surrounds the discharge tube (photo, bottom row). If the tube bursts, the shroud prevents the outer bulb from shattering. MH PAR lamps also may be used in open luminaires because they have a hard glass lens that contains the discharge tube (photo, top row).

Shrouded MH and MH PAR Lamps



Color

Manufacturers use two measures to specify lamp color: correlated color temperature (CCT) and color rendering index (CRI).

CCT. The correlated color temperature (CCT) describes the color appearance of a lamp in terms of a reference light source (blackbody radiator) operated at a given temperature, measured in kelvin (K). Lamps with CCTs of 3100 K or less usually are considered warm in appearance, those with CCTs of 4000 K and greater are cool, and those with CCTs between 3100 and 4000 K are considered neutral. Low-wattage MH lamps typically have CCTs of 2700–4300 K; low-wattage HPS lamps have CCTs of 2200–2800 K. In NLPPI’s evaluations, the median CCTs for most lamps were close to their rated values; a few differed by 500 K or more.

CRI. The color rendering index (CRI) value of a lamp describes the shift in color appearance of a set of reference color samples when illuminated by the lamp, compared with the color appearance of the same color samples when illuminated by a reference light source of comparable CCT (IESNA 1993). The maximum CRI value is 100. Low-wattage MH lamps commonly have CRI values of 65–96. Low-wattage color-corrected HPS lamps typically have CRI values of 65–85. HPS lamps with CRI values greater than 60 are called color-improved lamps; HPS lamps with CRI values of 70 or greater are called high CRI lamps. In NLPPI’s evaluations, the median values for most lamps were within five points of their rated CRI values; a few differed by more than five points.

Color Shift and Variation

HID lamps with the same rated CCT can appear to be different in color because of color shift and variations in manufacturing. Color shift occurs when a lamp’s CCT changes due to age, a change in the lamp’s position, or a variation of the supply voltage. MH lamps are more susceptible to color shift than HPS lamps; in fact, color concerns are often cited by specifiers as the principal barrier to more widespread use of MH lamps. Manufacturers report that newer MH lamps with ceramic

discharge tubes and high-CRI HPS lamps undergo minimal color shift over time.

Lamp aging. As an MH lamp operates, the mixture of the vaporized metal halides changes, which changes the lamp’s CCT (Meyer and Nienhuis 1988). Manufacturers customarily report color shift due to lamp aging as the maximum change in CCT from its initial value to its value at 40% of the lamp’s rated life. NLPPI did not measure color shift due to lamp aging for this report; manufacturer-supplied color shift values are provided in Tables 2-4.

Tilting. Tilting MH lamps can also cause color shift because it changes the mixture of the vaporized metal halides. NLPPI did not measure color shift from tilting for this report, but recommends that specifiers evaluate the specific lamp, ballast, and luminaire combination in a mock-up to determine possible effects of tilting on MH-lamp color.

Manufacturer variation. Lamps from different manufacturers that have the same rated CCT, and even new lamps from the same manufacturer, can have different color appearances and undergo color shift at different rates. To reduce the likelihood of noticeable color differences between lamps, NLPPI recommends that specifiers use lamps from the same manufacturer whenever possible and that specifiers encourage group relamping in their installations.

Life

Most lamp manufacturers report the average rated life of a lamp, which is the number of hours at which 50% of the lamps in a large test group are still operating under standard test conditions. For HID lamps, lamp life ratings are based on a 10-hours-on-1-hour-off operating cycle. Lamp life decreases if the lamps are on for less than 10 h per start. Operating lamps for 5, 2.5, and 1.25 h per start decreases life by approximately 25, 50, and 60%, respectively (GE Lighting 1993; Venture Lighting 1991). Lamp manufacturers generally publish derating factors so that specifiers can estimate average life for different operating cycles.

HID Lamp Shapes

The shape and size of an HID lamp’s outer bulb is designated by a letter, or group of letters, followed by a number. The letter(s) describes the shape of the bulb (see below), and the number describes the bulb’s diameter in eighths of an inch (in.). For example, a T10 lamp is tubular in shape and has a diameter of $10/8$, or $1\frac{1}{4}$, in.

- B: bulged
- BD: bulged dimpled
- T: tubular
- TD: tubular dimpled
- E: elliptical
- ED: elliptical dimpled
- PAR: parabolic aluminized reflector

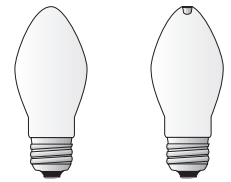

B-shaped (bulged) BD-shaped (bulged dimpled)

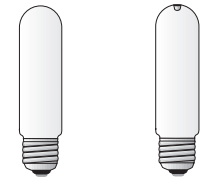

T-shaped (tubular) TD-shaped (tubular dimpled)

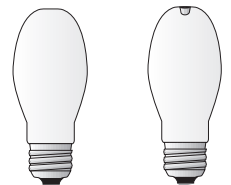

E-shaped (elliptical) ED-shaped (elliptical dimpled)

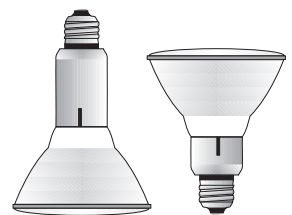

PAR-shaped (long neck) PAR-shaped (regular)

For universal-burn lamps, many manufacturers report different life values for horizontal and vertical positions. Universal-burn lamps have longer average rated lives for vertical positions than for horizontal positions. For example, the average rated life of a 100-W MH lamp is 10,000 h for the horizontal position and 15,000 h for the vertical position. NLRIP did not measure lamp life for this report.

Warm-Up and Restrike Time

Warm-up time is the time required for a cold HID lamp to start and reach a stable operating temperature and pressure. Some manufacturers publish warm-up times to 100% of maximum light output; others publish warm-up times to 95, 90, or 80% of maximum light output. Most HPS and MH lamps listed in Tables 2–4 on pp. 20–29 have rated warm-up times to 90% of maximum light output of 2–5 minutes (min).

If an HID lamp is extinguished, it must cool before being restarted. Restrike time is defined as the time required before the lamp will restart (IESNA 1993), although some manufacturers publish restrike times as the time required for the lamp to cool, restart, and reach 90% of maximum light output. The time required for the lamp to restart and warm up again is usually longer than the warm-up time for a cold lamp. HPS lamps have shorter restrike times than MH lamps. NLRIP did not measure warm-up or restrike times for this report.

Fading

In addition to light [between 380 and 770 nanometers (nm)], low-wattage HID lamps also emit ultraviolet (UV) energy (between 280 and 380 nm). MH lamps usually emit more UV energy than do HPS lamps. If objects such as denim blue jeans, meats, and museum artwork and artifacts are exposed to high levels of these wavelengths for an extended time, the color of these items may fade. Both MH and HPS lamps emit more UV than incandescent lamps. Specifiers should consult lamp manufacturers to determine

the amount of UV energy emitted by specific HID lamp types. UV filters sometimes are used in applications where fading is of concern.



Ballasts

Ballasts provide the proper voltage to start lamps, and they regulate starting and operating current. Many low-wattage HID lamps can operate on either magnetic or electronic ballasts, although electronic ballasts are not presently available for all lamp types. Electronic ballasts are lighter and smaller than their magnetic counterparts. They require less power to operate lamps but have higher initial costs. Magnetic ballasts for low-wattage lamps operate the lamps at 60 hertz (Hz); electronic ballasts can operate the lamps at 60 Hz or at much higher frequencies, such as 25 kilohertz (kHz).

Table 1 on p. 19 lists the manufacturers of ballasts for HID lamps and their telephone numbers. Specifiers should contact ballast manufacturers for comprehensive ballast information and specifications before specifying a ballast. Every ballast should have an American National Standards Institute (ANSI) code that identifies the electrical operating characteristics of the lamp it will operate.

Electronic Ballasts for Low-Wattage HPS Lamps

Philips Lighting's high-CRI HPS lamps operate on series controller ballasts, also called hybrid ballasts, from Advance Transformer Co. These ballasts use an electronic circuit in series with a magnetic transformer and operate the lamps at 60 Hz. Philips claims that these ballasts compensate for variations in supply voltage and thus provide uniform light source color characteristics within a $\pm 10\%$ line voltage variation and constant lamp voltage and power over lamp life (Philips Lighting 1991; Brabham 1990).

Electronic Ballasts for Low-Wattage MH Lamps

NLPIP identified two manufacturers of electronic ballasts for low-wattage MH lamps: OSRAM SYLVANIA INC. and WPI Electronics. According to OSRAM SYLVANIA, its ballast is designed specifically to operate its own 70-W double-ended MH lamp.

WPI's ballasts operate lamps at 60 Hz, whereas OSRAM SYLVANIA's ballasts operate lamps at between 20 and 25 kHz. Lamps operated at a frequency above 8 kHz can experience acoustic resonance, which can cause light output to fluctuate and lamps to flicker or even extinguish. OSRAM SYLVANIA's ballast operates lamps at a center frequency of 22.5 kHz and periodically shifts frequency up or down 2.5 kHz to overcome acoustic resonance, stabilize lamp operation, and minimize flicker (Faehnrich et al. 1988). Lamps operated at 60 Hz do not experience acoustic resonance (Rasch and Statnic 1991).

Results of NLPIP Ballast Evaluations

Fluctuations in the supply voltage can affect an MH lamp's light output, color, and power. Depending on the ballast used, higher voltage generally increases light output, decreases CCT, and increases lamp power; lower voltage

decreases light output, increases CCT, and decreases lamp power. Lamps operated by electronic ballasts maintain more consistent performance than those operated by magnetic ballasts because electronic ballasts maintain constant voltage to the lamp regardless of the supply voltage.

NLPIP evaluated the ability of ballasts to maintain lamp light output, CCT, and power during fluctuations of the supply voltage (see "Ballast Evaluations" on p. 14 for more information). NLPIP varied the supply voltage to four 70-W double-ended MH lamps operating on 120-volt (V), 60-Hz magnetic and 120-V electronic ballasts and obtained the following results:

Ballast and voltage effects on lamp performance

	Magnetic		Electronic	
	At 130 V	At 110 V	At 130 V	At 110 V
Lamp Light Output	+16 to +26%	-18 to -28%	0 to +2%	-2 to -6%
CCT	-100 to -400K	+300 to +600K	No Change to -100K	No Change to +200K
Lamp Power	+13%	-14 to -29%	No Change	No Change



Luminaires

NLPIP evaluated the ease of aiming and relamping of recessed and semi-recessed adjustable luminaires and track luminaires from seven manufacturers for this report.

Table 1 on p. 19 lists the manufacturers of HID accent luminaires and their telephone numbers. Tables 7–12 on pp. 32–45 contain manufacturer-supplied information for HID accent luminaires. NLPIP’s methods for evaluating luminaires are described in “Luminaire Evaluations” on p. 14. The results of NLPIP’s evaluations of HID accent luminaires are listed in Tables 13 and 14 on pp. 46–47 and described in “Results of NLPIP Luminaire Evaluations” on p. 11.

Luminaire Types

Recessed and semi-recessed adjustable luminaires. Recessed and semi-recessed HID accent luminaires appear very similar to recessed and semi-recessed accent luminaires for incandescent lamps. Figures 5 and 6 illustrate the components used in typical recessed and semi-recessed adjustable accent luminaires, respectively.

Track luminaires. Track and track luminaires for HID lamps are similar to track luminaires for incandescent lamps. They mount similarly, have similar optional accessories for additional optical control, and allow track heads to be electrically controlled individually or in groups. The track head is the part of the luminaire that moves along the track and usually comprises the lamp housing, lamp, socket, and reflector cone. The track head also typically contains the ballast for the HID lamp, unless the specifier chooses a monopoint mount, when the ballast is recessed into the ceiling plenum.

The track can be recessed into the ceiling, mounted to the surface of the ceiling, or suspended from the ceiling (pendant mounted). The track luminaires can be suspended from the track with a

Figure 5. Components of an Adjustable Accent Luminaire Recessed in a Ceiling

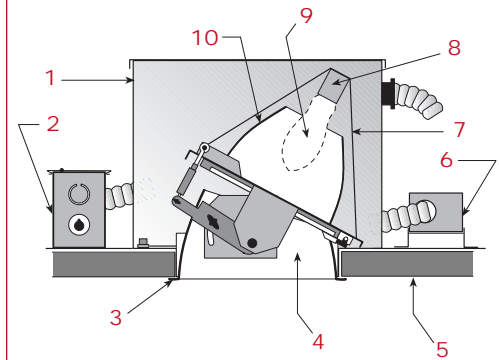

- 1 Luminaire housing
- 2 Junction box
- 3 Trim
- 4 Reflector cone
- 5 Ceiling
- 6 Ballast
- 7 Yoke assembly
- 8 Lamp socket
- 9 Lamp
- 10 Upper reflector

(Adapted with permission from Kurt Versen Inc. 1995)

Figure 6. Components of an Adjustable Accent Luminaire Semi-Recessed in a Ceiling

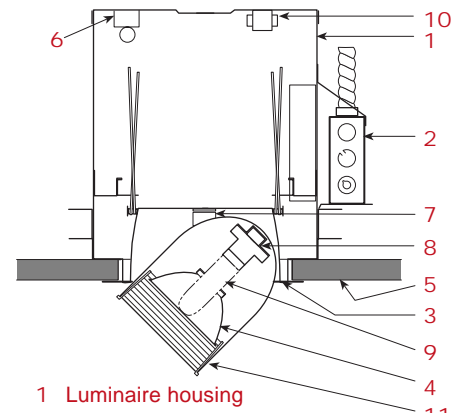

- 1 Luminaire housing
- 2 Junction box
- 3 Trim
- 4 Reflector cone
- 5 Ceiling
- 6 Electronic ballast and ignitor
- 7 Yoke assembly
- 8 Lamp socket
- 9 Lamp
- 10 Transformer
- 11 Lamp housing

(Adapted with permission from INDY Lighting Inc. 1995)

pendant mount, as shown in Figure 7. Some individual track luminaires can be mounted directly to a junction box in the ceiling without a track (see Figure 8). This option usually is called a mono-point mount.

Manufacturers of track luminaires for HID lamps offer accessories that change the optical control of the luminaire. These options include spread lenses that convert a round beam into an elongated beam and barn doors, louvers, and tubular shields ("snoot" shields) that help prevent direct glare. Specifiers should request the photometric information of a luminaire with any desired options before specifying the options. Filters also are available in many colors to change the color appearance of the light.

Tracks have one, two, or three circuits, allowing switching of up to three groups of track heads. An individual track head can also have its own switch at its connection to the track so that each head can be switched independently. Some track luminaires offer a ballast fuse, which

prevents damage to the lamp and ballast if there is a voltage surge.

Adjustability and Maintenance

NLPIP evaluated the ease of use of some of the components illustrated in Figures 5 and 6, some of which are used to adjust and aim HID accent luminaires. When these components are easy to use, the labor costs of installing and maintaining the luminaires are minimized. Components that are easy to use also make the luminaire less susceptible to being incorrectly adjusted or damaged during installation and maintenance.

Yoke assembly. The yoke assembly is used to aim the lamp. Some manufacturers provide mechanisms on the yoke so that it can be locked into position once the luminaire is aimed. Some lockable yokes have wing nuts that can be tightened by hand, while other yokes have bolts that should be tightened with a wrench.

Figure 7. Pendant-Mounted Track Luminaire

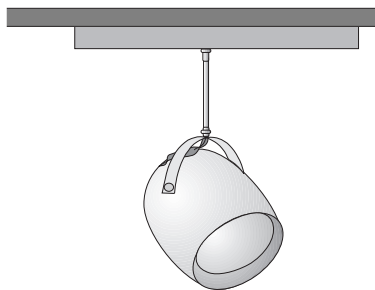

Figure 8. Monopoint Mounting of a Track Luminaire

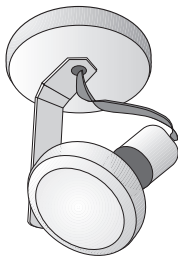
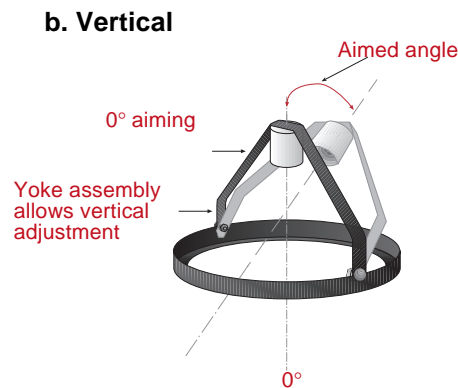
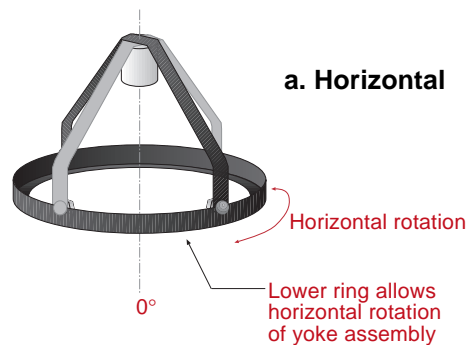

Figure 9. Horizontal and Vertical Aiming with Yoke Assembly



Adjustable luminaires can be aimed vertically and horizontally using the yoke assembly as illustrated in Figure 9 on p. 9. Recessed adjustable luminaires typically have vertical aiming ranges from 0–45°, where 0° is straight down, and horizontal rotation ranges from 0–360°. Semi-recessed adjustable and track luminaires typically have vertical aiming ranges from 0–90° and horizontal rotation ranges from 0–360°.

Upper reflector. The upper reflector directs light out of the luminaire in a specific direction and pattern. Three reflector system types are used in accent luminaires: interchangeable, adjustable, and fixed.

An interchangeable reflector system allows a user to change the reflectors on-site if necessary. Luminaires that use tubular MH and HPS lamps often have interchangeable reflector systems. Manufacturers commonly offer reflectors having spot, medium flood, and flood distributions. The number of available reflectors and distributions varies by luminaire. Figure 10 shows a luminaire that has two interchangeable reflectors.

Adjustable reflector systems usually have a mechanism that moves the reflector which changes from a spot to a flood distribution. Luminaires with adjustable reflectors usually house T10 HPS lamps. Figure 11 shows a luminaire with an adjustable reflector.

A fixed reflector system is neither adjustable nor interchangeable. Luminaires for ED17 and B17 lamps have fixed reflector systems and upper reflectors. A PAR lamp has an integral reflector, so luminaires for PAR lamps do not require an upper reflector and have a fixed reflector.

Reflector cone. The reflector cone provides a finished appearance to the luminaire, redirects any stray light from the upper reflector, and controls glare. Reflector cones are available in either specular (polished) or semi-specular finishes in colors such as clear, gold, black, bronze, and pewter. The most common combination of finish and color is specular clear, which is a shiny silver finish. Specular cones often appear dark because they reflect almost no light at

Figure 10. Interchangeable Reflectors



Figure 11. Adjustable Reflector

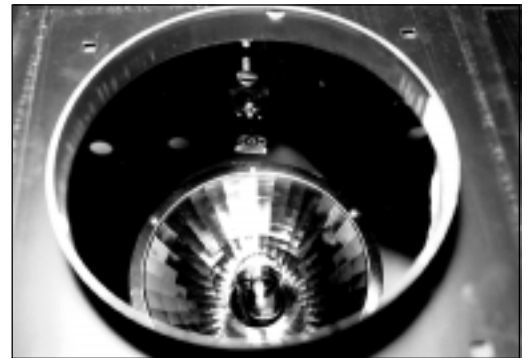

some viewing angles. A semi-specular finish scatters the light and provides a brighter cone appearance.

Reflector cones for recessed adjustable accent luminaires are typically round, although rectangular cones are available. Cones are available with either a flat or angled cut, as shown in Figure 12 on p. 11. Angle-cut cones typically are available in 20, 30, 35, and 45° angles; some manufacturers offer custom angles. The angle-cut cone enables the specifier to aim the lamp at greater vertical angles than the flat-cut cone allows, without trapping as much light within the luminaire.

Manufacturers use either springs or tension clips to attach reflector cones to the luminaire. Springs usually attach to the reflector cone and to the yoke and pull the reflector cone flush with the trim ring. Tension clips usually mount on the back side of the reflector cone and require the installer to push the reflector cone flush with the trim ring. If the cone is not flush, light can escape between the reflector cone and trim ring. Sometimes manufac-

Figure 12. Flat-Cut and Angle-Cut Reflector Cones



Figure 13. Reflector Cone with Trim Ring and Self-Flanged Cone

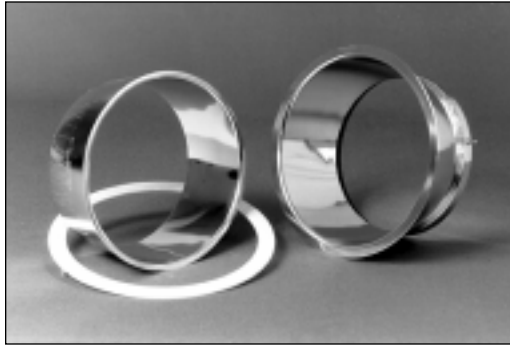

turers use a chain in addition to springs or tension clips. The chain normally connects the reflector cone to the yoke, which allows the cone to dangle during luminaire maintenance.

Trims. Trims cover the holes that are cut in the ceiling to install the reflector cones. Trims are available in one-piece and two-piece versions. One-piece trims are integral with the reflector cone and are referred to as self-flanged reflector cones (see Figure 13, right). Two-piece trims include the reflector cone and a trim ring, which is a separate piece of plastic or metal that is placed between the bottom flange of the reflector cone and the ceiling plane (see Figure 13, left).

Results of NLPiP Luminaire Evaluations

NLPiP's vertical aiming angle measurements for the semi-recessed and recessed luminaires revealed that most of the luminaires had aiming angles equal to or greater than the reported range. In most cases, manufacturers report vertical aiming range as the physical limit of the luminaire, which is what NLPiP measured. The useful range (the range over which most light leaves the luminaire in the desired direction) is often less than the physical range, particularly when a flat-cut cone is used, because at higher aiming angles, light can become trapped in the luminaire. Specifiers should evaluate samples of luminaires to ensure that the useful vertical aiming is adequate for the application. NLPiP's measurements of vertical aiming angles for track luminaires

agreed with those reported by the manufacturers.

The measured horizontal rotation angles of most luminaires were similar to the manufacturer-reported ranges, although some had horizontal rotation angles more than 10° less than the manufacturer-reported maximum. The support chain of one luminaire blocked complete rotation of the yoke and had to be disconnected before full rotation was possible. Specifiers should evaluate sample luminaires to ensure that the aiming angle and the vertical and horizontal rotation ranges are sufficient for the application.

NLPiP found that the ease of aiming and maintaining accent luminaires varies. In general, for lockable yokes, wing nuts and thumbscrews tightened and loosened more easily than hex bolts. Hex bolts generally required a wrench, but wing nuts and thumbscrews could be tightened by hand. NLPiP found that it was easier to reinstall reflector cones that had tension clips than those with springs because the springs were difficult to reattach to the luminaire housings. In addition, springs often fell off when the reflector cones were removed.

Selection Considerations

For applications that require a wide vertical aiming range, track luminaires generally are better than recessed or semi-recessed adjustable accent luminaires because track luminaires do not trap light within recessed housings. Additionally, track luminaires can be moved along the track to new positions as a display changes. However, recessed and

semi-recessed luminaires are less obtrusive (a “cleaner” ceiling plane) than track luminaires.

Recessed luminaires have smaller vertical aiming ranges than semi-recessed and track luminaires, but their ranges are adequate for most accent lighting applications. However, recessed accent luminaires for HID lamps are too large and bulky to fit into some plenums.

Specifiers can use manufacturer catalog sheets to review luminaire construction materials, available distributions, reflector types, and luminaire light distribution (see sidebar “Luminaire Light Distribution”). NLRIP recommends that specifiers examine a working sample for

quality of construction and, if possible, make a mock-up of the installation before specifying a luminaire.

Magnetic ballasts for HID lamps are extremely heavy. This causes installation and maintenance concerns, and, for track luminaires, may require structural support. Specifiers should consider luminaires with lamps that operate on electronic ballasts whenever available.

Luminaire manufacturers provide a ballast with each luminaire. Specifiers can request another compatible ballast, but before doing so, they should confirm ballast-lamp-luminaire compatibility with the respective manufacturers.

Luminaire Light Distribution

Luminaire manufacturers use candlepower distributions and illuminance charts to indicate the distribution of light from a luminaire. Both are useful estimates, but they do not consider aiming, lumen depreciation, or other maintenance factors.

Candlepower Distribution

The candlepower distribution curve illustrates the luminous intensity (candlepower) of the light at various angles. Luminaire manufacturers typically publish this curve for a luminaire using a specific lamp. When a different lamp is used, the distribution changes. Additionally, if the published curve is for a clear lamp and a specifier uses a coated lamp, the distribution changes. Most accent luminaire manufacturers publish the candlepower distribution curve of a luminaire oriented at 0° (the luminaire aimed downward; this orientation is also called nadir), some publish curves for a specific aiming angle only, and some publish curves for luminaires at both 0° and at an aiming angle. The candlepower distribution curves at the right are for a luminaire aimed at 0° and 25°.

Illuminance Chart

Many luminaire manufacturers publish charts that show illuminances [in footcandles (fc) or lux (lx)] that result from using various lamps in the luminaire at different mounting heights. The data typically are for the luminaire oriented at 0°. Illuminance charts are useful for quick estimates. An illuminance chart is shown below. The accompanying section view illustrates the illuminances at the angles listed in the chart for the 50-W coated MH lamp.

Mounting Height (ft)	Illuminance (fc)											
	10				15				20			
	0°	15°	25°	35°	0°	15°	25°	35°	0°	15°	25°	35°
Lamp Type												
50-W coated metal halide	37	12	4	1	16	5	2	0	9	3	1	0
70-W coated metal halide	54	17	6	1	24	8	2	0	13	4	1	0
100-W coated metal halide	85	27	9	2	38	12	4	1	21	7	2	0

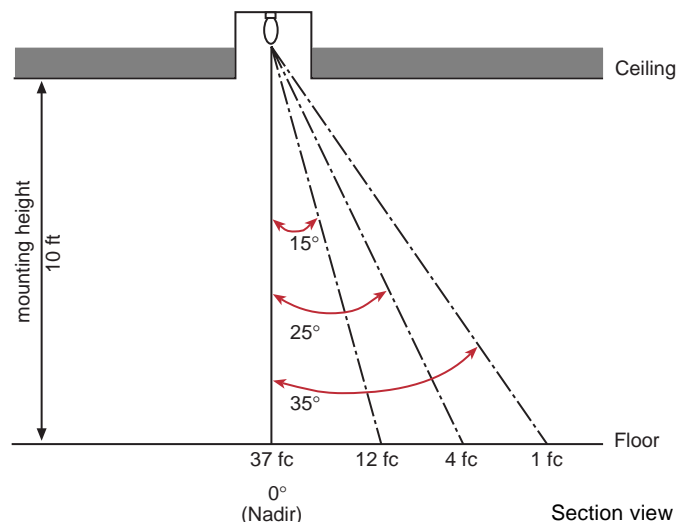
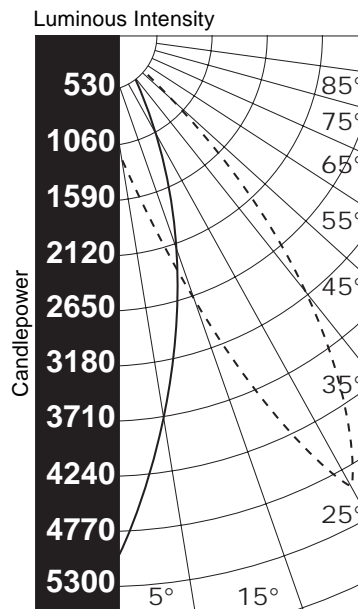



Alternative Technologies

Incandescent Accent Lighting Systems

Accent luminaires that use incandescent PAR lamps (including halogen and halogen infrared lamps) are the common alternative to HID accent lighting systems.

Incandescent PAR lamps and luminaires are smaller, lighter, and less expensive than HID lamps and luminaires, although at equal input power their intensities are not as great, and they have shorter lives. For example, a 100-W halogen infrared PAR lamp provides approximately 25% of the CBCP of a 100-W MH PAR lamp, and its lamp life is approximately 50% that of the MH PAR lamp. Incandescent PAR lamps can be dimmed, as can 100 and 150-W HID lamps.

One major advantage of incandescent systems relative to HID systems is that the color properties of an incandescent lamp remain relatively stable over its life, and there is little color variation between lamps. As described earlier, manufacturers of HID lamps are attempting to address color concerns in their new products.

Low-Voltage Systems

Low-voltage halogen lamps (typically 6, 12, or 24 V) are used for display and accent lighting applications because they have very precise, sharply defined beam patterns. Low-voltage halogen lamps and their luminaires are smaller, lighter, and less expensive than HID systems. However, because low-voltage halogen lamp life is less than HID lamp life and because HID lamps have higher efficacies than low-voltage lamps, the life-cycle costs of an HID system can be lower than those of a low-voltage halogen system. Low-voltage halogen systems can be dimmed; however, specifiers should verify the compatibility of the dimmer and the transformer with the dimmer manufacturer.

Cost

The cost of an HID accent lighting system depends on the lamp, ballast, and luminaire; on the quantity of units purchased; and on other application and market factors. HID accent luminaires typically cost two to three times more than incandescent accent luminaires, although the greater light output of an HID lamp can allow a specifier to use fewer luminaires. Additionally, the longer average rated life of HID lamps means the life-cycle costs of HID accent lighting systems can be less than those of incandescent accent lighting systems. Because initial costs for HID accent lighting systems depend on several factors, NLPPI did not include specific price information in this report. Specifiers should consult manufacturers or distributors for prices.

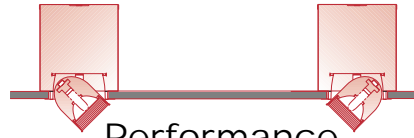

Performance Evaluations

Lamp Evaluations

Under NLPPI's direction, Lighting Sciences Inc. [LSI] of Scottsdale, Arizona, measured initial light output, CCT, and CRI according to ANSI testing standards. According to LSI, light output measurements are accurate to $\pm 2\%$. CCT and CRI measurements are accurate to $\pm 4\%$. All lamps were seasoned for 100 h and measurements were taken directly after seasoning.

NLPPI tested a total of 41 HPS lamps from three manufacturers, 20 medium-base MH lamps from five manufacturers, 14 double-ended MH lamps from four manufacturers, and seven MH PAR38 lamps from two manufacturers. With the exception of the double-ended MH lamps, which operate in a horizontal position, all lamps were tested in a vertical base-up position.

To evaluate the effect of operating position on light output, NLPPI tested four samples of each of two manufacturers' 100-W ED17 lamps and three samples of each of two manufacturers' 70-W PAR38 lamps. The medium-base, universal-burn MH lamps were operated at 0° (vertical, base up), 30° , and 90° (horizontal). The supply voltage was 120 V, and all lamps had been seasoned for 100 h. NLPPI found insignificant changes in light output for all lamps tested in the three orientations, so no data are reported for these tests.

For most lamps, manufacturers donated two samples and NLPPI purchased two samples on the open market. In a few cases, NLPPI tested fewer than four samples because samples were unavailable

or failed during testing; Tables 5 and 6 on pp. 30–31 show the number of lamps tested.

Table 5 shows the results of NLPPI’s lamp performance testing for medium-base HPS lamps and for medium-base and double-ended MH lamps. Table 6 shows the results for MH PAR lamps. NLPPI’s tests revealed no significant differences between the measured performances of donated and purchased lamps.

Ballast Evaluations

NLPPI tested the operation of 70-W double-ended MH lamps operating on magnetic and electronic ballasts. Tests were performed at the Lighting Research Center’s laboratory in Watervliet, New York. NLPPI selected one lamp from each of four manufacturers (GE Lighting, OSRAM SYLVANIA, Philips, and Ushio America) for testing on a magnetic ballast (Advance Transformer Co. catalog number 72C5280-N-P) and an electronic ballast (WPI catalog number EM85-120-S01). Both ballasts operate lamps at 60 Hz.

With 120 V applied to the ballast, NLPPI started the lamps and operated them for 30 min. NLPPI measured light output, CCT, and lamp power at various input voltage settings between 90–140 V. The OSRAM SYLVANIA, Philips, and Ushio lamps failed when operated on magnetic ballasts after NLPPI increased the supply voltage to 140 V. Therefore,

NLPPI reduced the maximum supply voltage to 130 V for tests on the magnetic ballast and used new lamp samples. See p. 7 for the results of this evaluation.

Luminaire Evaluations

NLPPI evaluated luminaires at the Lighting Research Center. NLPPI asked manufacturers to submit two samples of each luminaire that they manufacture for low-wattage HID lamps. Not all manufacturers that submitted luminaire data submitted samples for testing. NLPPI evaluated one sample each of seven recessed adjustable luminaires for MH lamps, five recessed adjustable luminaires for HPS lamps, two semi-recessed adjustable luminaires for HPS lamps, and five track luminaires for MH lamps. Tables 13 and 14 on pp. 46–47 present the results of the testing.

Two NLPPI researchers evaluated the ease with which luminaires could be aimed and relamped. NLPPI mounted luminaires on a pipe system that simulated mounting in a ceiling (see below). Researchers stood on ladders to conduct the evaluations. NLPPI also checked whether the luminaires had UL and maximum power labels. To measure the vertical and horizontal aiming ranges, NLPPI placed the luminaires on tables and measured the adjustment ranges.

Mounted Luminaires for NLPPI Testing

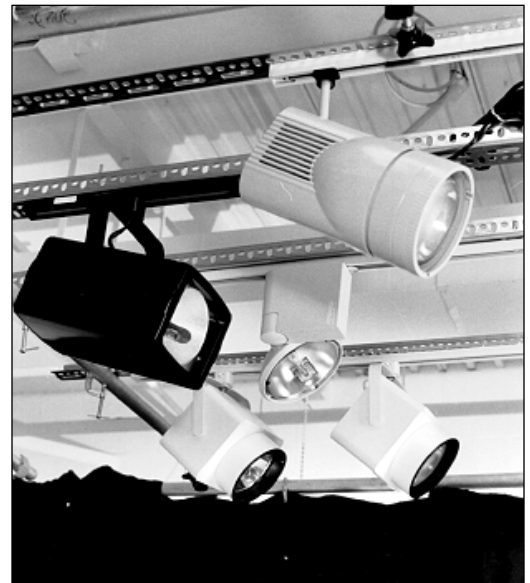
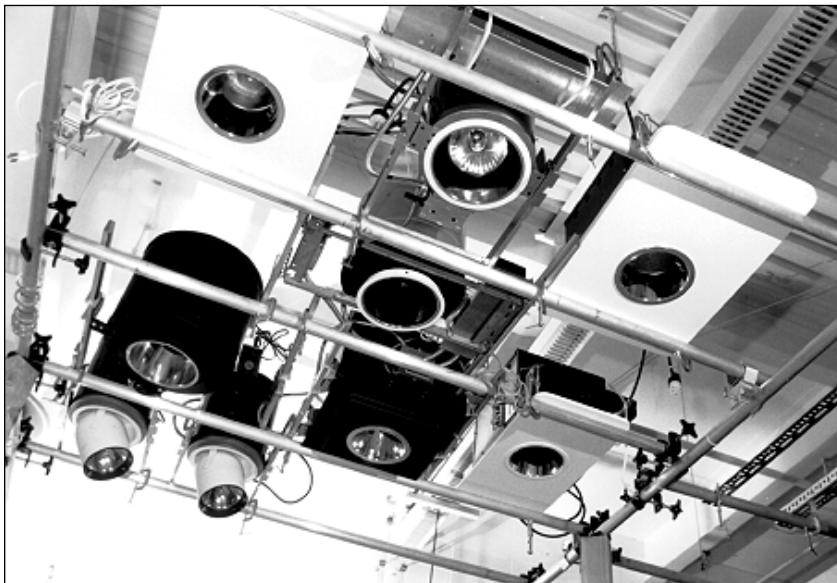



Further Information

American National Standards Institute. 1980. *American National Standard Nomenclature for Glass Bulbs Intended for Use With Electric Lamps*, ANSI C79.1-1980. New York, NY: American National Standards Institute.

———. 1984. *American National Standard for Electric Lamps: High Intensity Discharge Lamps: Method of Designation*, ANSI C78.380-1984. New York, NY: American National Standards Institute.

———. 1990. *American National Standard for Electrical Lamp Bases*, ANSI C81.61-1990. New York, NY: American National Standards Institute.

Brabham, D. E. 1990. Improved Color HPS Lamps: Systems Considerations and a Comparison of Commercial Lamps. *Journal of the Illuminating Engineering Society* 19(1):110–117.

Carleton, S. A., and R. A. J. Keijsers. 1992. Stabilization of White HPS Lamps. *Journal of the Illuminating Engineering Society* 21(1):47–51.

deGroot, J. J., and J. A. J. M. van Vliet. 1986. *The High-Pressure Sodium Lamp*. Philips Technical Library. Deventer, Netherlands: Kluwer Technische Boeken B.V.

Faehrich, H. J., and E. Rasch. 1988. Electronic Ballasts for Metal Halide Lamps. *Journal of the Illuminating Engineering Society* 17(2):131–140.

Fromm, D. C., and J. Heider. 1991. Color Rendering, Color Shift, and Lumen Maintenance of Low-Wattage Metal Halide Lamps. *Journal of the Illuminating Engineering Society* 20(1):77–83.

GE Lighting. 1993. *GE Lighting 9200 Lamp Catalog*. 21st ed. Cleveland, OH: General Electric Company.

Illuminating Engineering Society of North America. 1993. *Lighting Handbook: Reference & Application*. 8th ed. M. S. Rea, editor. New York, NY: Illuminating Engineering Society of North America.

Ji, Y., and R. Wolsey. 1994. Vol. 1, No. 3, *Lighting Answers: Dimming Systems for High Intensity Discharge Lamps*. Troy, NY: Lighting Research Center, Rensselaer Polytechnic Institute.

Ji, Y. 1994. *Specifier Reports: Electronic Ballasts*. Vol. 2, No. 3. Troy, NY: Lighting Research Center, Rensselaer Polytechnic Institute.

Meyer, C., and H. Nienhuis. 1988. *Discharge Lamps*. Deventer, Netherlands: Kluwer Technische Boeken B.V.

OSRAM SYLVANIA INC. 1994. *Product Catalog*. Danvers, MA: OSRAM SYLVANIA INC.

Philips Lighting. 1991. *Guide to High Intensity Discharge Lamps*, P-2685. Somerset, NJ: Philips Lighting Company.

———. 1993. *Lamp Specification and Application Guide*, SAG-100. Somerset, NJ: Philips Lighting Company.

Rasch, E., and E. Statnic. 1991. Behavior of Metal Halide Lamps with Conventional and Electronic Ballasts. *Journal of the Illuminating Engineering Society* 20(2):88–96.

Steffy, G. R. 1990. *Architectural Lighting Design*. New York, NY: Van Nostrand Reinhold.

Underwriters Laboratories Inc. 1990. *Standard for High Intensity Discharge Lighting Fixtures*, ANSI/UL 1572-1990. Northbrook, IL: Underwriters Laboratories.

Unglert, M. C., and R. M. Kane. 1980. The Interaction of High-Pressure Sodium Lamps, Ballasts and Luminaires. *Lighting Design & Application (LD+A)* 10(11):43–47.

U.S. Congress. 1992. *Energy Policy Act of 1992*. Public Law 102-486. 102nd Cong. 24 October 1992.

Venture Lighting. 1991. *Lamp Catalog and Technical Guide*. Solon, OH: Venture Lighting International.



Data Table Terms & Definitions

The succeeding data tables contain data from the manufacturers on their lamps and luminaires. The tables also include the results of NLRIP's testing.

The following alphabetical list contains brief definitions of many of the headings used in the tables. For additional information, refer to the text.

Active power. The total input power, in watts. Active power is the nominal lamp power when operated on a reference ballast. In Tables 2–4, active power is the total power of the lamp and the ballast normally supplied with a luminaire by the manufacturer.

Aiming access. The opening through which a lamp in a luminaire can be aimed, either through the aperture or from above.

ANSI code. Indicates the electrical operating designation of the lamp, which must match that of the ballast.

Aperture diameter. The diameter of the reflector cone opening, expressed in inches.

Average rated life. The number of hours at which half of a large group of lamps has failed under standard test conditions.

Ballast access. The opening through which the ballast in a luminaire can be installed or replaced, either through the aperture or from above the luminaire.

Beam angle. The angle at which the luminous intensity is half of the maximum intensity.

Bulb finish. The coating, if any, that is applied to the inside surface of the bulb. Finishes are either clear, phosphor coated, or diffuse.

Bulb designation. An abbreviation of the shape and size of the lamp's outer envelope; the letter or letters indicate the shape and the numbers indicate the bulb's maximum diameter in eighths of an inch. For example, an ED17 is an elliptical, dimpled lamp that is $1\frac{7}{8}$ in. ($2\frac{1}{8}$ in.) in diameter.

CBCP. Center beam candlepower (CBCP) is the luminous intensity at the center of the beam, expressed in candelas (cd). In the luminaire tables, CBCP values are reported for a 0° (vertical, base-up) lamp orientation.

CCT. Correlated color temperature which describes the color appearance of the light that is produced as compared to a reference source.

Circuits. The number of circuits that the track can control. Many manufacturers offer one, two, or three circuit tracks.

CRI. Color rendering index. A scale for describing the effect of a light source on the color appearance of objects being illuminated, with 100 representing the reference condition and being the maximum CRI possible.

CSA. Canadian Standards Association.

Color shift. The change in the lamp's correlated color temperature at 40% of the lamp's rated life, in kelvin.

Damp location label. A label provided by the manufacturer that indicates that the luminaire can be safely used in a damp area.

Efficacy. The lamp's initial light output divided by its active power, expressed in lumens per watt.

Horizontal rotation range. The total angular horizontal rotation of the lamp-reflector assembly.

Initial light output. The lamp's light output in lumens, after 100 h of seasoning.

Lamp shield type. The material used in the luminaire to shield the lamp from the environment. Lamp shields are required by UL for some lamp types.

Lockable aiming position. The position of a luminaire can be locked with this feature after aiming.

Locking device. The wing nuts, thumbscrews, or hex bolts used for locking the luminaire in place once it is correctly aimed.

Luminaire efficiency. The ratio of light emitted by the luminaire (in lumens) and the light output of the lamp-ballast combination (in lumens) used in the luminaire.

Luminaire options. Options available for recessed and semi-recessed HID luminaires, including
Auxiliary lamp: a small additional incandescent lamp wired to the emergency power circuit that ignites immediately if the HID lamp is extinguished.
Ballast fuse: a fuse in a luminaire that prevents damage to the lamp and ballast by extinguishing the luminaire if it detects a surge in voltage.

Luminaire requirements. Whether a lamp should be operated in an open or an enclosed luminaire.

Operating position. The manufacturer-recommended operating position for the lamp.

Recessed depth. The total depth of the housing required to install a luminaire recessed into a ceiling plenum.

Reflector cone finish. The finish of the interior surface of the cone.

Reflector cone trim. The plastic or metal component that covers the hole cut in the ceiling to install the reflector cone.

Reflector system type. The type of upper reflector (adjustable, fixed, or interchangeable) found in accent luminaires.

Relamping access. The opening through which the lamp in a luminaire can be replaced, either through the aperture or from above the luminaire.

Restrike time. The time it takes for the lamp to produce 90% of its initial light output after it has been extinguished and immediately restarted, unless otherwise indicated.

Sloped ceiling adapter. Whether the luminaire needs an adapter supplied by the manufacturer that enables mounting the luminaire in a sloped ceiling.

Track head diameter. Size of the luminaire used in a track lighting system.

Track luminaire options. Accessories available for track luminaires, including

Barn doors: Typically, four adjustable shields that are attached to the face of the luminaire to reduce glare.

Louver: A fixed black shield, usually divided into small cells, that is attached to the face of a luminaire to reduce direct glare.

Monopoint mounting: The track luminaire is mounted to a junction box recessed in the ceiling.

Pendant mounting: A suspension device between the mount and the luminaire.

Snoot shield: A tubular shield that helps prevent glare.

Spread lens: A lens that converts a round beam of light to an elongated beam.

Switch on track connector: A switch for an individual track luminaire that permits the luminaire to be switched independently.

Track mounting. For track luminaires, the method by which the track is attached to the ceiling.

Vertical aiming range. The range of angular vertical tilt of a luminaire's lamp-reflector assembly, in degrees.

Warm-up time. The time it takes for a lamp to produce 90% of its initial light output when it is started, unless otherwise indicated.

Weight. The weight of the luminaire plus ballast (except for certain track luminaires with separately mounted ballasts, when the weight is that of the lamp and track head only).

List of Tables

Table 1.	Manufacturer-Supplied Information: Telephone Numbers for Customer Inquiries	19
Table 2.	Manufacturer-Supplied Information: HPS Lamps	20
Table 3.	Manufacturer-Supplied Information: MH Lamps	22
Table 4.	Manufacturer-Supplied Information: MH PAR Lamps	26
Table 5.	NLPIP-Measured Data: HPS and MH Lamps Excluding MH PAR Lamps	30
Table 6.	NLPIP-Measured Data: MH PAR Lamps	30
Table 7.	Manufacturer-Supplied Information: Recessed Adjustable Accent Luminaires for HPS Lamps	
	a. with Adjustable Reflectors	32
	b. with Interchangeable Reflectors	32
Table 8.	Manufacturer-Supplied Information: Recessed Adjustable Accent Luminaires for MH Lamps	34
Table 9.	Manufacturer-Supplied Information: Semi-Recessed Adjustable Accent Luminaires for HPS Lamps	
	a. With Adjustable Reflectors	38
	b. With Interchangeable Reflectors	38
Table 10.	Manufacturer-Supplied Information: Semi-Recessed Adjustable Accent Luminaires for MH Lamps	40
Table 11.	Manufacturer-Supplied Information: Track Luminaires for HPS and MH Lamps	42
Table 12.	Manufacturer-Supplied Information: Luminaire Supplement	44
Table 13.	NLPIP-Measured Data: Recessed and Semi-Recessed Adjustable Luminaires	46
Table 14.	NLPIP-Measured Data: Track Luminaires	46

Products were received from manufacturers by September 1993. NLPIP tested products from November 1993 to November 1994. Products tested by NLPIP may thereafter be used by the Lighting Research Center for research or demonstration purposes, or otherwise used. Tables 2-4 contain manufacturer-provided data through August 1996. NLPIP compiled data for Tables 7-11 from information provided by luminaire manufacturers in 1994; Table 12 provides supplemental data provided by the manufacturers in 1996.

**Table 1. Manufacturer-Supplied Information:
Telephone Numbers for Customer Inquiries**

Lamp Manufacturers	
GE Lighting	216-266-2121
Iwasaki Electric Company, Limited	800-255-LAMP
OSRAM SYLVANIA INC.	508-777-1900
Philips Lighting Company	908-563-3000
Ushio America, Incorporated	714-229-3120
Venture Lighting International, Incorporated	216-248-0600
Ballast Manufacturers	
Advance Transformer Company	708-390-5000
MagneTek	201-967-7600
OSRAM SYLVANIA INC.	508-777-1900
Robertson	312-785-7177
Valmont Electric	1-800-533-7290
WPI Electronics	603-456-3111
Luminaire Manufacturers	
Capri Lighting	213-726-1800
Edison Price Lighting	212-838-5212
Kramer Lighting Company	516-754-0390
Kurt Versen Company	201-664-8200
INDY Lighting, Incorporated	317-849-1233
Lightolier	508-679-8131
Lithonia Lighting	317-362-1837
Miroreflector Company, Incorporated	516-371-1111
Staff Lighting	914-691-6262

Table 2. Manufacturer-Supplied Information: HPS Lamps
(Products marked with ✚ were tested by NLRIP)

Manufacturer	Catalog Number	Active Power (W)	Bulb Designation	Bulb Finish	Operating Position ^a	Enclosure Required	ANSI Code
Medium Base							
GE Lighting	LU70/DX/MED	70	B17	clear	U	N	S62
	LU70/DX/D/MED	70	B17	diffuse	U	N	S62
	✚ LU95/SP28/MED	95	T10	clear	U	N	NS
	✚ LU95/SP28/D/MED	95	B17	diffuse	U	N	NS
	LU150/DX/MED	150	B17	clear	U	N	S55
	✚ LU150/DX/D/MED	150	B17	diffuse	U	N	S55
Iwasaki Electric Co. Ltd.	✚ NHT50SDX	50	T30	clear	U	N	S68
	✚ NHT50FSDX	50	T30	diffuse	U	N	S68
	✚ NHT100SDX	100	T35	clear	U	N	S54
	NHT150SDX	150	T40	clear	U	N	S56
Philips Lighting Co.	✚ C150S55/C/D/M	150	ED17	diffuse	U	N	S55
	✚ SDW-50W/LV/D	50	ED17	diffuse	U	NS	S104
	✚ SDW-100W/LV/D	100	ED17	diffuse	U	N	S105
PG-12 Base							
Philips Lighting Co.	SDW-T35W/LV	32	T10	clear	U	N	S99
	✚ SDW-T50W/LV	50	T10	clear	U	N	S104
	✚ SDW-T100W/LV	100	T10	clear	U	N	S105

NS = not supplied

^a BU = base up; BU±15 = base up ±15°; BU/BD±15 = base up or base down ±15°; H = horizontal; H±15 = horizontal ±15°; H±45 = horizontal ±45°; U = universal; V±15 = vertical ±15°.

^b Initial light output values are based on operating position. For some universal burn lamps, the values are reported for horizontal (H) or vertical (V) operating position.

^c Efficacy values are based on initial light output.

Table 3. Manufacturer-Supplied Information: MH Lamps
(Products marked with ✚ were tested by NLRIP)

Manufacturer	Catalog Number	Active Power (W)	Bulb Designation	Bulb Finish	Operating Position ^a	Enclosure Required
G12 Base						
GE Lighting	CMH35/T/30/G12	35	T6	clear	U	N
	CMH70/T/30/G12	70	T6	clear	U	N
	CMH150/T/30/G12	150	T6	clear	U	N
Philips Lighting Co.	CDM35/T6/830	39	T6	clear	U	Y
	CDM70/T6/830	72	T6	clear	U	Y
	CDM150/T6/830	147	T6	clear	U	Y

NS = not supplied

^a BU = base up; BU±15 = base up ±15°; BU/BD±15 = base up or base down ±15°; H = horizontal; H±15 = horizontal ±15°; H±45 = horizontal ±45°; U = universal; V±15 = vertical ±15°.

^b Initial light output values are based on operating position. For some universal-burn lamps, the values are reported for horizontal (H) or vertical (V) operating position.

^c Efficacy values are based on initial light output.

Initial Light Output (lm) ^b	Efficacy (LPW) ^c	Average Rated Life (h) ^d	CCT (K)	CRI	Color Shift (K) ^e	Warm-up Time (min) ^f	Restrike Time (min) ^f
3,800	54	10,000	2,200	65	- <100	3-4	1
3,600	51	10,000	2,200	65	- <100	3-4	1
5,200	55	10,000	2,800	70	-25	3-4	1
4,800	50	10,000	2,800	70	-25	3-4	1
10,500	70	15,000	2,290	65	- <100	3-4	1
9,900	66	15,000	2,290	65	- <100	3-4	1
2,500	50	6,000	2,500	82	±50	8 ^g	8 ^c
2,400	48	6,000	2,500	82	±50	8 ^g	8 ^c
5,000	50	6,000	2,500	83	±50	15 ^g	15 ^c
7,800	52	9,000	2,500	85	±50	15 ^g	15 ^c
11,000	73	15,000	2,200	65	NS	3-4 ^h	1
2,190	44	10,000	2,700	85	-200	3 ^h	0.5
4,470	45	10,000	2,700	85	-200	3 ^h	0.5
1,250	40	10,000	2,600	85	-200	3 ^h	0.5
2,300	46	10,000	2,700	85	-200	3 ^h	0.5
4,700	47	10,000	2,700	85	-200	3 ^h	0.5

^d Average rated life values are based on a 10 h per start unless otherwise indicated.

^e Color shift is reported for 40% of rated life.

^f Values are to 90% light output unless otherwise indicated.

^g Warm-up and restrike times are to 100% light output.

^h Warm-up and restrike times are to 80% light output.

ANSI Code	Initial Light Output (lm) ^b	Efficacy (LPW) ^c	Average Rated Life (h) ^d	CCT (K)	CRI	Color Shift (K) ^e	Warm-up Time (min) ^f	Restrike Time (min) ^f
NS	3,000	86	6,000	3,000	80	NS	NS	NS
M98	6,200	89	6,000	3,000	80	NS	NS	NS
M102	13,500	90	6,000	3,000	80	NS	NS	NS
M130	3,100 V	89	9,000	3,000	80	±200	3	NS
M85	6,200 V	89	6,000	3,000	83	±200	3	NS
M81	13,500 V	90	6,000	3,000	85	±200	3	NS

^d Average rated life values are based on a 10 h per start unless otherwise indicated.

^e Color shift is reported for 40% of rated life.

^f Values are to 90% light output unless otherwise indicated.

^g Warm-up and restrike times are to 100% light output.

^h Warm-up and restrike times are to 80% light output.

Table 3 (continued). Manufacturer-Supplied Information: MH Lamps
(Products marked with ✚ were tested by NLRIP)

Manufacturer	Catalog Number	Active Power (W)	Bulb Designation	Bulb Finish	Operating Position ^a	Enclosure Required
Medium Base						
GE Lighting	MXR32/C/VBU/0	32	ED17	coated	VBU ±15	N
	MVR50/U/MED ^g	50	BD17	clear	U	Y
	CMH70/U/MED ^g	70	BD17	clear	U	N
	MVR70/U/MED ^g	70	BD17	clear	U	Y
	MXR70/U/MED ^g	70	BD17	clear	U	Y
	CMH100/U/MED ^g	100	BD17	clear	U	N
	MVR100/U/MED ^g	100	BD17	clear	U	Y
	MXR100/U/MED	100	BD17	clear	U	Y
	✚ MXR100/C/U/MED	100	ED17	coated	U	Y
	MVR150/U/MED ^g	150	BD17	clear	U	Y
MXR150/U/MED ^g	150	BD17	clear	U	Y	
Iwasaki Electric Co. Ltd.	MT70SDW	70	T11	clear	U	N
	✚ MT70FSDW	70	T11	coated	U	N
	MT70SW ^g	70	T11	clear	U	N
	MT70D	70	T11	clear	U	N
	MT150SDW ^g	150	T12	clear	U	N
	MT150SW	150	T12	clear	U	N
	MT150D	150	T12	clear	U	N
OSRAM SYLVANIA INC.	MP70/U/MED	70	ED17	clear	U	N
	MP100/U/MED	100	ED17	clear	U	N
	✚ MP100/C/U/MED	100	ED17	coated	U	N
Philips Lighting Co.	CDM70/U/M ^g	70	ED17	clear	U	Y
	MH70/U/M ^g	70	ED17	clear	U	Y
	CDM100/V/M ^g	100	ED17	clear	V±15	Y
	MH100/U/M	100	ED17	clear	U	Y
	MS100/BU/BD/M/3K	100	ED17	clear	BU/BD ±15	Y
	✚ MS100/C/BU/BD/M/3K	100	ED17	coated	BU/BD ±15	Y
Venture Lighting International, Inc.	MH50/U ^j	50	BD17	clear	U	Y
	MP50/U/3K ^j	50	ED17	clear	U	N
	MH70/U	70	BD17	clear	U	Y
	MH70/C/U	70	BD17	coated	U	Y
	MP70/U	70	ED17	clear	U	N
	MP70/C/U	70	ED17	coated	U	N
	MP70/U/3K	70	BD17	clear	U	Y
	MP70/C/U/27K	70	ED17	coated	U	N
	MH100/U	100	BD17	clear	U	Y

NS = not supplied

^a BU = base up; BU±15 = base up ±15°; BU/BD±15 = base up or base down ±15°; H = horizontal; H±15 = horizontal ±15°; H±45 = horizontal ±45°; U = universal; V±15 = vertical ±15°.

^b Initial light output values are based on operating position. For some universal burn lamps, the values are reported for horizontal (H) or vertical (V) operating position.

^c Efficacy values are based on the initial light output.

^d Average rated life values are based on 10-hours per start unless otherwise indicated. Letters after the value indicate if the value is based on vertical (V), horizontal (H), or both (V/H) operating positions.

^e Color shift is reported for 40% of rated life.

ANSI Code	Initial Light Output (m) ^b	Efficacy (LPW) ^c	Average Rated Life (h) ^d	CCT (K)	CRI	Color Shift (K) ^e	Warm-up Time (min) ^f	Restrike Time (min) ^f
M100	2,500	78	10,000 V	3,200	70	NS	2-4	10-15
M110	3,000	60	5,000 V/H	4,000	75	NS	2-4	10-15
M98	6,200	89	10,000	3,000	80	NS	NS	NS
M98	4,700	67	12,000 V/H	4,000	75	NS	2-4	10-15
M88	5,500	79	12,000	3,200	70	NS	NS	NS
M90	9,200	92	10,000	3,000	80	NS	NS	NS
M90	8,100	81	15,000 V/H	4,000	75	NS	2-4	10-15
M90	9,000	90	15,000	3,200	70	NS	NS	NS
M90	8,500	85	15,000	3,200	70	NS	NS	NS
M102	11,700	78	15,000 V/H	4,000	75	NS	2-4	10-15
M102	13,000	87	15,000	3,200	70	NS	NS	NS
M85; M98	4,500	64	7,500 H	3,500	96	±250	4	10
M85; M98	4,300	61	7,500 H	3,500	96	±250	4	10
M85; M98	5,000	71	7,500 H	4,500	96	±250	4	10
M85; M98	5,000	71	7,500 H	6,500	96	±250	4	10
M102	10,000	66	7,500 H	3,500	96	±250	4	10
M102	11,000	73	7,500 H	4,500	96	±250	4	10
M102	11,000	73	7,500 H	6,500	96	±250	4	10
M98	5,200	74	15,000 V; 10,000 H	3,000	75	±200	2	5-10
M90	8,500	85	15,000 V; 10,000 H	3,000	75	±200	2	5-10
M90	7,900	79	15,000 V; 10,000 H	2,900	75	±200	2	5-10
M98	6,200	89	7500	3,000	83	±200	NS	NS
M98	5,000	71	5,000 V/H ^h	4,300	65	NS	0.75 ⁱ	2
M90	9,500	95	10,000	3,000	85	±200	NS	NS
M90	7,800	78	10,000 V/H	4,300	65	NS	4 ⁱ	4-8
M90	8,500	85	10,000 V	3,200	65	NS	0.75 ⁱ	4-8
M90	8,500	85	10,000 V	3,200	70	NS	4 ⁱ	4-8
M110	3,400	68	10,000 V; 7,500 H	4,000	65	±200	1-2	1-2
M110	3,400	68	10,000 V; 7,500 H	3,200	65	±200	1-2	2-4
M98	5,600	70	15,000 V; 11,250 H	4,000	65	±200	1-2	1-2
M98	5,300	71	15,000 V; 11,250 H	3,700	70	±200	1-2	1-2
M98	5,200	71	15,000 V; 11,250 H	4,000	65	±200	1-2	2-4
M98	5,600	72	15,000 V; 11,250 H	3,700	70	±200	1-2	2-4
M98	5,200	85	15,000 V; 11,250 H	3,200	65	±200	1-2	2-4
M98	5,000	72	15,000 V	2,700	70	±200	1-2	2-4
M90	9,000	78	15,000 V; 11,250 H	4,000	65	±200	1-2	2-4

^f Values are to 90% light output unless otherwise indicated.

^g Also available with a coated finish, usually with slightly lower initial light output.

^h Reported average rated life is for universal burning position at 10 h per start.

ⁱ Warm-up time is to 80% light output.

^j Also available with a coated finish, usually with a higher CRI and a slightly different CCT.

^k Lamp has an R7s base.

^l Lamp has an Rx7s base.

^m Warm-up time is to 95% light output.

Table 3 (continued). Manufacturer-Supplied Information: MH Lamps
(Products marked with ❖ were tested by NLRIP)

Manufacturer	Catalog Number	Active Power (W)	Bulb Designation	Bulb Finish	Operating Position ^a	Enclosure Required
Medium Base (continued)						
Venture Lighting International, Inc.	MH100/C/U	100	BD17	coated	U	Y
	MP100/U	100	ED17	clear	U	N
	MP100/C/U	100	ED17	coated	U	N
	MP100/C/V/27K	100	ED17	coated	V	N
	MP100/U/3K	100	ED17	clear	U	N
	❖ MP100/C/U/3K	100	ED17	coated	U	N
	MH150/U	150	BD17	clear	U	Y
	MH150/C/U	150	BD17	coated	U	Y
	MS150/V	150	ED17	clear	BU/BD ±15	Y
RSC Base						
GE Lighting	CMH70/TD/30/RX7s ^k	70	TD6	clear	U	N
	❖ MQI/70/T6/30 ^l	70	T6	clear	H ±45	Y
	CMH150/TD/30/RX7s ^k	150	TD6	clear	U	N
	MQI/150/T7/43 ^l	150	T7	clear	H ±45	Y
OSRAM SYLVANIA INC.	M70/T6/DE	70	T6	clear	H ±15	Y
	❖ HQI-DE 70/NDX	70	T6	clear	H ±45	Y
Philips Lighting Co.	CDM70/TD/830 ^l	70	T6	clear	H ±45	Y
	CDM150/TD/830 ^l	150	T7	clear	H ±45	Y
	❖ MHN-TD70W	70	T6	clear	H	Y
	MHN-TD150	150	T7	clear	H	Y
Ushio America, Inc.	❖ UHI-70DW, DL, DM ^k	75	T6	clear	H	Y
	UHI-150DW, DL, DM ^k	150	T6	clear	H	Y

NS = not supplied

^a BU = base up; BU±15 = base up ±15°; BU/BD±15 = base up or base down ±15°; H = horizontal; H±15 = horizontal ±15°; H±45 = horizontal ±45°; U = universal; V±15 = vertical ±15°.

^b Initial light output values are based on operating position. For some universal burn lamps, the values are reported for horizontal (H) or vertical (V) operating position.

^c Efficacy values are based on the initial light output.

^d Average rated life values are based on 10-hours per start unless otherwise indicated. Letters after the value indicate if the value is based on vertical (V), horizontal (H), or both (V/H) operating positions.

^e Color shift is reported to 40% of rated life.

ANSI Code	Initial Light Output (lm) ^b	Efficacy (LPW) ^c	Average Rated Life (h) ^d	CCT (K)	CRI	Color Shift (K) ^e	Warm-up Time (min) ^f	Restrike Time (min) ^f
M90	8,500	78	15,000 V; 11,250 H	3,700	70	±200	1–2	2–4
M90	8,500	78	15,000 V; 11,250 H	4,000	65	±200	1–2	4–6
M90	8,100	85	15,000 V; 11,250 H	3,700	70	±200	1–2	4–6
M90	8,100	78	15,000 V	2,700	70	±150	1–2	4–6
M90	8,500	78	15,000 V; 10,000 H	3,200	65	±200	1–2	4–6
M90	8,100	85	15,000 V; 11,250 H	3,200	70	±200	1–2	4–6
M102	15,000	90	15,000 V; 11,250 H	4,000	65	±200	1–2	2–4
M102	14,250	90	15,000 V; 11,250 H	3,700	70	±200	1–2	2–4
M57	13,500	90	10,000 V	4,000	65	±200	2–3	4–8
M98	6,200	89	6,000	3,000	80	NS	NS	NS
M85	5,000	71	6,000 H	3,000	75	±100	3–5	10–12
M102	13,500	90	6,000	3,000	80	NS	NS	NS
M81	11,250	75	6,000 H	4,300	75	±100	3–5	10–12
M85	5,200	74	7,500 H	3,200	70	±200	2	5–10
M85	5,500	79	8,000 H	3,900	81	±200	2	5–10
M85 or M98	6,200	89	6,000	3,000	82	±200	3	NS
M81	13,500	90	6,000	3,000	85	±200	3	NS
M85	5,500	78	6,000 H	4,200	80	NS	3 ^m	4
M81	11,250	75	10,000 H	4,200	80	NS	3 ^m	4
M85	5,000; 5,500; 5,500	80	6,000 H	3,000; 3,500; 4,200	75	±0–150	3	NS
M81	12,000	80	6,000 H	3,000; 3,500; 4,200	75	±0–150	3	NS

^f Values are to 90% light output unless otherwise indicated.

^g Also available with a coated finish, usually with slightly lower initial light output.

^h Reported average rated life is for universal burning position at 10 h per start.

ⁱ Warm-up time is to 80% light output.

^j Also available with a coated finish, usually with a higher CRI and a slightly different CCT.

^k Lamp has an Rx7s base.

^l Lamp has an R7s base.

^m Warm-up time is to 95% light output.

Table 4. Manufacturer-Supplied Information: MH PAR Lamps
(Products marked with ✚ were tested by NLRIP)

Manufacturer	Catalog Number	Active Power (W)	Bulb Designation	Enclosure Required	ANSI Code	Initial Light Output (lm)
Medium Base						
GE Lighting	CMH70/PAR30/SP	70	PAR30	N	M98	4,100
	CMH70/PAR30/FL	70	PAR30	N	M98	4,100
	CMH70/U/PAR/SP	70	PAR38	N	M98	4,100
	CMH70/U/PAR/FL	70	PAR38	N	M98	4,100
	MXR70/U/PAR/SP (12°)	70	PAR38	N	M98	3,700
	MXR70/U/PAR/FL (40°)	70	PAR38	N	M98	3,700
	MXR70/U/PAR/WFL (65°)	70	PAR38	N	M98	3,700
	CMH100/U/PAR/SP	100	PAR38	N	M90	6,300
	CMH100/U/PAR/FL	100	PAR38	N	M90	6,300
	MXR100/U/PAR/SP (12°)	100	PAR38	N	M90	5,700
	MXR100/U/PAR/FL (40°)	100	PAR38	N	M90	5,700
	MXR100/U/PAR/WFL (65°)	100	PAR38	N	M90	5,700
Philips Lighting Co.	CDM35/PAR20/M/SP	35	PAR20	N	M130	2,300
	CDM35/PAR20/M/FL	35	PAR20	N	M130	2,300
	CDM35/PAR30/M/SP	35	PAR30L ^d	N	M130	2,400
	CDM35/PAR30/M/FL	35	PAR30L ^d	N	M130	2,400
	CDM70/PAR30/M/SP	70	PAR30L ^d	N	M98	4,500
	CDM70/PAR30/M/FL	70	PAR30L ^d	N	M98	4,500
	CDM70/PAR38/SP	70	PAR38	N	M98	4,800
	CDM70/PAR38/FL	70	PAR38	N	M98	4,800
	CDM100/V/PAR38/SP	100	PAR38	N	M90	7,000

NS = not supplied

All lamps are universal burn.

^a Average rated life values are based on 10 h per start unless otherwise indicated. Letters after the life value indicate if the value is based on vertical (V), horizontal (H), or both (V/H) operating positions.

^b Color shift is reported to 40% of rated life.

^c Warm-up and restrike times are to 90% light output unless otherwise indicated.

^d Lamp has a long-neck design.

^e Average rated life value is based on 5.5 h per start.

Efficacy (LPW)	CBCP (cd)	Beam Angle (°)	Average Rated Life (h) ^a	CCT (K)	CRI	Color Shift (K) ^b	Warm-up Time (min) ^c	Restrike Time (min) ^c
59	45,000	10	9,000	3,000	80	NS	NS	NS
59	18,000	30	9,000	3,000	80	NS	NS	NS
59	30,000	15	7,500	3,000	80	NS	NS	NS
59	10,000	40	7,500	3,000	80	NS	NS	NS
53	50,000	12	7,500	3,000	70	NS	NS	NS
53	8,500	40	7,500	3,000	70	NS	NS	NS
53	3,200	65	7,500	3,000	70	NS	NS	NS
63	45,000	15	7,500	3,000	80	NS	NS	NS
63	15,000	40	7,500	3,000	80	NS	NS	NS
57	54,000	12	7,500	3,000	70	NS	NS	NS
57	10,000	40	7,500	3,000	70	NS	NS	NS
57	4,500	65	7,500	3,000	70	NS	NS	NS
66	28,000	10	7,500	3,000	81	±200	NS	NS
66	6,000	30	7,500	3,000	81	±200	NS	NS
69	42,000	10	9,000	3,000	81	±200	NS	NS
69	6,500	30	9,000	3,000	81	±200	NS	NS
64	48,000	10	6,000	3,000	83	±200	NS	NS
64	7,000	40	6,000	3,000	83	±200	NS	NS
69	28,000	15	7,500	3,000	83	±200	NS	NS
69	16,000	30	7,500	3,000	83	±200	NS	NS
70	28,000	15	7,500	3,000	83	±200	NS	NS

Table 4 (continued). Manufacturer-Supplied Information: MH PAR Lamps
 (Products marked with ✚ were tested by NLRIP)

Manufacturer	Catalog Number	Active Power (W)	Bulb Designation	Enclosure Required	ANSI Code	Initial Light Output (lm)
Medium-Skirted Base						
OSRAM SYLVANIA INC.	MP70PAR38/U/SP20	70	PAR38	N	M98	3,200
	✚ MP70PAR38/U/FL35	70	PAR38	N	M98	3,500
	MP70PAR38/U/VWFL65	70	PAR38	N	M98	3,600
Philips Lighting Co.	CDM100/V/PAR38/SP	100	PAR38	NS	M90	7,000
	CDM100/V/PAR38/FL	100	PAR38	NS	M90	7,000
Venture Lighting International, Inc.	MP70/U/PAR38/3K/20	70	PAR38	N	M98	3,200
	MP70/U/PAR38/3K/35	70	PAR38	N	M98	3,500
	MP70/U/PAR38/3K/65	70	PAR38	N	M90	3,600
	MP100/U/PAR38/3K/20	100	PAR38	N	M90	5,200
	MP100/U/PAR38/3K/35	100	PAR38	N	M90	5,500
	MP100/U/PAR38/3K/65	100	PAR38	N	M90	5,600
Extended Mogul End-Prong Base						
GE Lighting	MBI150/PAR64/30N	150	PAR64	N	M81	10,350
	MBI150/PAR64/40N	150	PAR64	N	M81	10,125
	MBI150/PAR64/30M	150	PAR64	N	M81	10,350
	MBI150/PAR64/40M	150	PAR64	N	M81	10,125

NS = not supplied

All lamps are universal burn.

^a Average rated life values are based on 10 h per start unless otherwise indicated. Letters after the life value indicate if the value is based on vertical (V), horizontal (H), or both (V/H) operating positions.

^b Color shift is reported to 40% of rated life.

^c Warm-up and restrike times are to 90% light output unless otherwise indicated.

^d Lamp has a long-neck design.

^e Average rated life value is based on 5.5 h per start.

Efficacy (LPW)	CBCP (cd)	Beam Angle (°)	Average Rated Life (h) ^a	CCT (K)	CRI	Color Shift (K) ^b	Warm-up Time (min) ^c	Restrike Time (min) ^c
46	18,000	20	8,500 V/H	3,200	75	±200	2	5–10
50	10,000	35	8,500 V/H	3,200	75	±200	2	5–10
51	3,000	65	8,500 V/H	3,200	75	±200	2	5–10
70	32,000	15	7,500	3,000	85	±200	.75	4–8
70	21,000	30	7,500	3,000	85	±200	.75	4–8
67	18,000	20	7,500 V; 5,625 H	3,200	75	±200	1–2	2–4
67	10,000	35	7,500 V; 5,625 H	3,200	75	±200	1–2	2–4
67	3,000	65	7,500 V; 5,625 H	3,200	75	±200	1–2	2–4
65	26,000	20	7,500 V; 5,625 H	3,200	75	±200	1–2	4–6
65	12,000	35	7,500 V; 5,625 H	3,200	75	±200	1–2	4–6
65	4,500	65	7,500 V; 5,625 H	3,200	65	±200	1–2	4–6
69	300,000	3	6,000 V/H ^e	3,000	80	NS	1	1–2
67	300,000	3	6,000 V/H ^e	4,000	85	NS	1	1–2
69	50,000	13	6,000 V/H ^e	3,000	80	NS	1	1–2
67	50,000	13	6,000 V/H ^e	4,000	85	NS	1	1–2

Table 5. NLP-IP-Measured Data: HPS and MH Lamps Excluding MH PAR Lamps

Manufacturer	Lamp Type	Catalog Number	Bulb Finish	Number of Samples
HPS, Color Improved (Vertical)				
GE Lighting	150-W Deluxe Lucalox	LU150/DX/D/MED	diffuse	4
Philips Lighting Co.	150-W Ceramalux Comfort	C150S55/C/D/M	diffuse	4
HPS,CRI (Vertical)				
Iwasaki Electric Co. Ltd.	50-W Daylux T10	NHT50SDX	clear	3
	50-W Daylux T10	NHT50FSDX	frosted	4
	100-W Daylux T10	NHT100SDX	clear	3
GE Lighting	95-W White Lucalox T10	LU95/SP28/MED	clear	4
	95-W White Lucalox B17	LU95/SP28/D/MED	diffuse	4
Philips Lighting Co.	50-W White Son ED17	SDW-50W/LV/D	diffuse	4
	50-W White Son T10	SDW-T50W/LV	clear	4
	100-W White Son ED17	SDW-100W/LV/D	diffuse	4
	100-W White Son T10	SDW-T100W/LV	clear	3
MH, Medium Base (Vertical)				
GE Lighting	100-W Halarc	MXR100/C/U/MED	coated	4
Iwasaki Electric Co. Ltd.	70-W Color Arc	MT70FSDW	frosted	4
OSRAM SYLVANIA INC.	100-W ProTech	MP100/C/U/MED	coated	4
Philips Lighting Co.	100-W	MS100/C/BU/BD/M/3K	coated	4
Venture Lighting International, Inc.	100-W Pro-Arc	MP100/C/U/3K	clear	4
MH, Double Ended with RSC Base (Horizontal)				
GE Lighting	70-W MQI	MQI/70/T6/30	NA	4
OSRAM SYLVANIA INC.	70-W HQI	HQI-DE70/NDX	NA	4
Philips Lighting Co.	70-W	MHN-TD 70W	NA	4
Ushio America, Inc.	70-W	UHI-70 DW	NA	2

Ranges reported are for all samples tested.

Table 6. NLP-IP-Measured Data: MH PAR Lamps

Manufacturer	Lamp Type	Catalog Number	Number of Samples	Initial Light Output (lm)
OSRAM SYLVANIA INC.	70-W Pro-Tech flood	MP70PAR38/U/FL35	4	3,000–3,400
Venture Lighting International, Inc.*	70-W Pro-Arc flood	MH70/PAR38/FL	3	4,600–4,900

Ranges reported are for all samples tested.

* According to the manufacturer, this lamp has been discontinued.

Initial Light Output (lm)	CCT (K)	CRI
7,500–9,900	2,200–2,500	69–86
9,200–10,000	2,200–2,300	66–73
2,400–2,800	2,300–2,500	72–83
2,500–2,900	2,300–2,500	72–83
3,700	2,400–2,600	87–88
6,600–7,800	2,100–2,300	56–72
5,300–5,700	2,200–2,300	71–77
2,000–2,800	2,500–2,700	72–84
1,500–2,400	2,600–3,100	74–84
5,300–5,800	2,600	83–85
3,500–3,900	2,500–2,700	80–90
9,200–9,600	2,900–3,200	63–65
3,600–4,700	4,000–4,200	94–96
9,000–9,600	2,800–3,100	71–72
9,400–9,900	3,000–3,200	67–68
9,600–10,200	3,200–3,400	67–73
4,300–4,400	3,200–3,400	74–76
5,800–6,100	4,200–4,400	73–75
2,500–5,600	4,100–4,600	73–79
6,100–6,400	3,500	70–71

CBCP (cd)	Beam Angle (°)	CCT (K)	CRI
5,900–7,200	36–37	3,100–3,500	61–65
7,200–8,600	36–45	3,300–3,500	60–63

Table 7. Manufacturer-Supplied Information: Recessed Adjustable Accent Luminaires for HPS Lamps

a. With Adjustable Reflectors

Manufacturer	Catalog Number	Lamp Type	Active Power (W)	Beam Angle ^a		CBCP ^a		Luminaire Efficiency (%)
				at Max. (°)	at Min. (°)	at Max. (cd)	at Min. (cd)	
Edison Price Lighting	Spot White/6	35-W T10 White Son	45	30	10	NS	NS	NS
	Spot White/6	50-W T10 White Son	68	30	10	21,000	46,000	57 ^e
	Spot White/6	100-W T10 White Son	120	30	10	NS	NS	NS
	Spot White/7	35-W T10 White Son	45	30	10	NS	NS	NS
	Spot White/7	50-W T10 White Son	68	30	10	NS	NS	NS
	Spot White/7	100-W T10 White Son	120	30	10	20,000	54,000	59 ^e

NS = not supplied

1 in. = 2.54 cm 1 lb = 0.45 kg

^a Max.: maximum distribution; Min.: minimum distribution.

^b B: black; C: clear; ChG: champagne gold. Finish given in bold is standard.

^c SF: self-flanged; TR: trim ring.

^d All luminaires in this table are compatible with sloped ceilings. Contact manufacturer for slope limits.

^e Narrow focus.

b. With Interchangeable Reflectors

(Products marked with **+** were tested by NLPPIP)

Manufacturer	Catalog Number	Lamp Type	Active Power (W)	Distributions Available (°)	CBCP (cd)	Beam Angle (°)	Luminaire Efficiency (%)	Aperture Diameter (in.)
Indy Lighting	+ 404R-35	35-W T10 White Son	45	5 12 30	43,000 23,000 2,000	6 10 25	56	7 ³ / ₈
	+ 404R-50	50-W T10 White Son	68	5 12 30	79,000 42,000 4,000	6 10 25	56	7 ³ / ₈
	404R-100	100-W T10 White Son	120	12 30	73,000 8,000	10 25	56	7 ³ / ₈
Staff Lighting	682-WS035-CL-1	35-W T10 White Son	55	9	16,000	9	66	6 ¹ / ₄
	684-WS035-CL-1	35-W T10 White Son	55	29	3,000	28	61	6 ¹ / ₄
	682-WS050-CL-1	50-W T10 White Son	70	9	29,000	9	66	6 ¹ / ₄
	684-WS050-CL-1	50-W T10 White Son	70	29	5,000	28	61	6 ¹ / ₄
	682-WS100-CL-1	100-W T10 White Son	120	9	59,000	9	66	6 ¹ / ₄
	+ 684-WS100-CL-1	100-W T10 White Son	120	29	11,000	28	61	6 ¹ / ₄

NS = not supplied

1 in. = 2.54 cm 1 lb = 0.45 kg

^a C: clear; CH: champagne; G: gold; S: specular. Finish given in bold is standard.

^b SF: self-flanged; TR trim ring.

^c All luminaires in this table are compatible with sloped ceilings. Contact manufacturer for slope limits.

^d F: Ballast fuse.

Aperture Diameter (in.)	Recessed Depth (in.)	Horizontal Rotation Range (°)	Vertical Aiming Range (°)	Lockable Aiming Position	Weight (lb)	Reflector Cone Finish ^b	Reflector Cone Trim ^c	Sloped Ceiling Adaptor Required ^d	Damp Location Label	Luminaire Options	Labeling
6	11 ³ / ₄	0–358	0–40	yes	26	B, C, ChG	SF	NA	yes	no	UL
6	11 ³ / ₄	0–358	0–40	yes	26	B, C, ChG	SF	NA	yes	no	UL
6	11 ³ / ₄	0–358	0–40	yes	26	B, C, ChG	SF	NA	yes	no	UL
7	11 ³ / ₄	0–358	0–40	yes	26	B, C, ChG	SF	NA	yes	no	UL
7	11 ³ / ₄	0–358	0–40	yes	26	B, C, ChG	SF	NA	yes	no	UL
7	11 ³ / ₄	0–358	0–40	yes	26	B, C, ChG	SF	NA	yes	no	UL

Recessed Depth (in.)	Horizontal Rotation Range (°)	Vertical Aiming Range (°)	Lockable Aiming Position	Weight (lb)	Reflector Cone Finish ^a	Reflector Cone Trim ^b	Sloped Ceiling Adaptor Required ^c	Damp Location Label	Luminaire Options ^d	Labeling
12	0–355	0–35	no	10	Ch, S	TR	yes	yes	none	UL, CSA
12	0–355	0–35	no	10	Ch, S	TR	yes	yes	none	UL, CSA
12	0–355	0–35	no	10	Ch, S	TR	yes	yes	none	UL, CSA
10 ⁵ / ₈	0–362	0–35	yes	29	C, G	SF	no	no	F	UL
10 ⁵ / ₈	0–362	0–35	yes	29	C, G	SF	no	no	F	UL
10 ⁵ / ₈	0–362	0–35	yes	29	C, G	SF	no	no	F	UL
10 ⁵ / ₈	0–362	0–35	yes	29	C, G	SF	no	no	F	UL
10 ⁵ / ₈	0–362	0–35	yes	29	C, G	SF	no	no	F	UL
10 ⁵ / ₈	0–362	0–35	yes	29	C, G	SF	no	no	F	UL

Table 8. Manufacturer-Supplied Information: Recessed Adjustable Accent Luminaires for MH Lamps
(Products marked with ✚ were tested by NLRIP)

Manufacturer	Catalog Number	Lamp Type	Active Power (W)	CBCP (cd)	Beam Angle (°)	Luminaire Efficiency (%)	Aperture Diameter (in.)	Recessed Depth (in.)	Horizontal Rotation Range (°)
Luminaires for PAR38 Lamps									
Capri Lighting	MHAD 15/70-RMS40	70-W spot	94	18,000	20	81	5 ³ / ₄	8 ¹ / ₂	0–358
	MHAD 15/70-RMS40	70-W flood	94	10,000	35	90	5 ³ / ₄	8 ¹ / ₂	0–358
	✚ MHAD 15/100-RMS40	100-W spot	125	26,000	20	92	5 ³ / ₄	8 ¹ / ₂	0–358
	MHAD 15/100-RMS40	100-W flood	125	12,000	35	90	5 ³ / ₄	8 ¹ / ₂	0–358
	MHAD 15/150-RMS40	150-W spot	180	34,000	20	92	5 ³ / ₄	8 ¹ / ₂	0–358
	MHAD 15/150-RMS40	150-W flood	180	17,000	35	90	5 ³ / ₄	8 ¹ / ₂	0–358
Indy Lighting	426R-70-SP	70-W spot	94	18,000	20	93	7 ³ / ₈	12	0–355
	426R-70-FL	70-W flood	94	10,000	35	89	7 ³ / ₈	12	0–355
	426R-70-VWFL	70-W very wide flood	94	3,000	65	94	7 ³ / ₈	12	0–355
	✚ 426R-100-SP	100-W spot	129	26,000	20	94	7 ³ / ₈	12	0–355
	426R-100-FL	100-W flood	129	12,000	35	90	7 ³ / ₈	12	0–355
	426R-100-VWFL	100-W very wide flood	129	4,500	65	95	7 ³ / ₈	12	0–355
Kurt Versen	R7411	70-W spot	94	12,805	24	86	7 ¹ / ₄	11 ³ / ₈	0–358
	R7411	70-W flood	94	7,194	36	75	7 ¹ / ₄	11 ³ / ₈	0–358
	R7411	100-W spot	125	20,806	24	86	7 ¹ / ₄	11 ³ / ₈	0–358
	R7411	100-W flood	125	11,306	36	76	7 ¹ / ₄	11 ³ / ₈	0–358
Lightolier	AA6C 70HDCL	70-W spot	90	28,000	15	100	6	11	0–358
	AA6C 70HDCL	70-W flood	90	16,000	30	100	6	11	0–358
	AA6C 70HDCL	70-W wide flood	90	4,000	65	100	6	12 ¹ / ₂	0–358
	AA7C 70HDCL	70-W spot	90	20,000	15	100	7 ³ / ₈	12 ¹ / ₂	0–358
	AA7C 70HDCL	70-W flood	90	16,000	30	100	7 ³ / ₈	12 ¹ / ₂	0–358
	AA7C 70HDCL	70-W wide flood	90	4,000	65	100	7 ³ / ₈	11	0–358
	AA6C 10HDCL	100-W spot	126	40,000	15	100	6	11	0–358
	AA6C 10HDCL	100-W flood	126	21,000	30	100	6	11	0–358
	AA6C 10HDCL	100-W wide flood	126	6,000	65	100	6	11	0–358
	✚ AA7C 10HDCL	100-W spot	126	40,000	15	100	7 ³ / ₈	12 ¹ / ₂	0–358
	AA7C 10HDCL	100-W flood	126	21,000	30	100	7 ³ / ₈	12 ¹ / ₂	0–358
AA7C 10HDCL	100-W wide flood	126	6,000	65	100	7 ³ / ₈	12 ¹ / ₂	0–358	

NS = not supplied

1 in. = 2.54 cm 1 lb = 0.45 kg

All luminaires in this table have a fixed reflector system.

^a Lamp shields are not required for luminaires that use MH PAR lamps (UL 1990).

^b FA: from above; TA: through aperture.

^c B: black; BB: black baffle; Br: bronze; C: clear; Ch: champagne; ChG: champagne gold; G: gold; Gr: gray; P: pewter; S: specular; SGC: soft glow clear; SGP: soft glow pewter; SGW: soft glow wheat; SS: semi-specular; W: wheat. Finish given in bold is standard.

^d SF: self-flanged; TR: trim ring.

^e All luminaires in this table are compatible with sloped ceilings. Contact manufacturer for slope limits.

^f AL: auxiliary lamp; EC: emergency circuit; F: ballast fuse.

Vertical Aiming Range (°)	Lockable Aiming Position	Lamp Shield Type ^a	Aiming Access ^b	Relamping Access ^b	Ballast Access ^b	Weight (lb)	Reflector Cone Finish ^c	Reflector Cone Trim ^d	Sloped Ceiling Adaptor Required ^e	Damp Location Label	Luminaire Options ^f	Labeling
0-35	yes	NA	TA	TA	FA/TA	16	B, BB, C, G	TR	no	yes	F	UL, CSA
0-35	yes	NA	TA	TA	FA/TA	16	B, BB, C, G	TR	no	yes	F	UL, CSA
0-35	yes	NA	TA	TA	FA/TA	16	B, BB, C, G	TR	no	yes	F	UL, CSA
0-35	yes	NA	TA	TA	FA/TA	16	B, BB, C, G	TR	no	yes	F	UL, CSA
0-35	yes	NA	TA	TA	FA/TA	16	B, BB, C, G	TR	no	yes	F	UL, CSA
0-35	yes	NA	TA	TA	FA/TA	16	B, BB, C, G	TR	no	yes	F	UL, CSA
0-35	no	NA	TA	TA	TA	20	BB, Ch, S, SS	TR	yes	yes	F	UL, CSA
0-35	no	NA	TA	TA	TA	20	BB, Ch, S, SS	TR	yes	yes	F	UL, CSA
0-35	no	NA	TA	TA	TA	20	BB, Ch, S, SS	TR	yes	yes	F	UL, CSA
0-35	no	NA	TA	TA	TA	20	BB, Ch, S, SS	TR	yes	yes	F	UL, CSA
0-35	no	NA	TA	TA	TA	20	BB, Ch, S, SS	TR	yes	yes	F	UL, CSA
0-35	no	NA	TA	TA	TA	20	BB, Ch, S, SS	TR	yes	yes	F	UL, CSA
0-45	yes	NA	FA/TA	FA/TA	TA	24	B, Br, G, P, S, SGC, SGP, SGW, W	SF	no	yes	F	UL
0-45	yes	NA	FA/TA	FA/TA	TA	24	B, Br, G, P, S, SGC, SGP, SGW, W	SF	no	yes	F	UL
0-45	yes	NA	FA/TA	FA/TA	TA	26	B, Br, G, P, S, SGC, SGP, SGW, W	SF	no	yes	F	UL
0-45	yes	NA	FA/TA	FA/TA	TA	26	B, Br, G, P, S, SGC, SGP, SGW, W	SF	no	yes	F	UL
0-35	no	NA	FA/TA	FA/TA	FA/TA	NS	B, C, G	SF	no	yes	F	UL, CSA
0-35	no	NA	FA/TA	FA/TA	FA/TA	NS	B, C, G	SF	no	yes	F	UL, CSA
0-35	no	NA	FA/TA	FA/TA	FA/TA	NS	B, C, G	SF	no	yes	F	UL, CSA
0-35	no	NA	FA/TA	FA/TA	FA/TA	NS	B, C, G	SF	no	yes	AL, EC, F	UL, CSA
0-35	no	NA	FA/TA	FA/TA	FA/TA	NS	B, C, G	SF	no	yes	AL, EC, F	UL, CSA
0-35	no	NA	FA/TA	FA/TA	FA/TA	NS	B, C, G	SF	no	yes	AL, EC, F	UL, CSA
0-35	no	NA	FA/TA	FA/TA	FA/TA	NS	B, C, G	SF	no	yes	F	UL, CSA
0-35	no	NA	FA/TA	FA/TA	FA/TA	NS	B, C, G	SF	no	yes	F	UL, CSA
0-35	no	NA	FA/TA	FA/TA	FA/TA	NS	B, C, G	SF	no	yes	AL, EC, F	UL, CSA
0-35	no	NA	FA/TA	FA/TA	FA/TA	NS	B, C, G	SF	no	yes	AL, EC, F	UL, CSA
0-35	no	NA	FA/TA	FA/TA	FA/TA	NS	B, C, G	SF	no	yes	AL, EC, F	UL, CSA
0-35	no	NA	FA/TA	FA/TA	FA/TA	NS	B, C, G	SF	no	yes	AL, EC, F	UL, CSA

Table 8 (continued). Manufacturer-Supplied Information: Recessed Adjustable Accent Luminaires for MH Lamps (Products marked with ✚ were tested by NLPPIP)

Manufacturer	Catalog Number	Lamp Type	Active Power (W)	CBCP (cd)	Beam Angle (°)	Luminaire Efficiency (%)	Aperture Diameter (in.)	Recessed Depth (in.)	Horizontal Rotation Range (°)
Luminaires for PAR38 Lamps (continued)									
Lithonia Lighting ^g	DH 50M 7ACT 120	50-W spot	72	10,300	20	90	7 ¹ / ₂	11 ³ / ₄	0–355
	DH 50M 7ACT 120	50-W flood	72	4,900	35	90	7 ¹ / ₂	11 ³ / ₄	0–355
	DH 70M 7ACT 120	70-W spot	90	16,120	20	90	7 ¹ / ₂	11 ³ / ₄	0–355
	DH 70M 7ACT 120	70-W flood	90	7,560	35	90	7 ¹ / ₂	11 ³ / ₄	0–355
	DH 100M 7ACT 120	100-W spot	125	26,000	20	90	7 ¹ / ₂	11 ³ / ₄	0–355
	DH 100M 7ACT 120	100-W flood	125	12,000	35	90	7 ¹ / ₂	11 ³ / ₄	0–355
Staff Lighting	5457-MH70CL-D	70-W spot	89	18,000	20	NA	6 ¹ / ₄	10 ⁵ / ₈	0–362
	5457-MH70CL-D	70-W flood	89	10,000	35	NA	6 ¹ / ₄	10 ⁵ / ₈	0–362
	5457-MH70CL-D	70-W very wide flood	89	3,000	65	NA	6 ¹ / ₄	10 ⁵ / ₈	0–362
	5457-MH100CL-D	100-W spot	129	26,000	20	NA	6 ¹ / ₄	10 ⁵ / ₈	0–362
	5457-MH100CL-D	100-W flood	129	12,000	35	NA	6 ¹ / ₄	10 ⁵ / ₈	0–362
	5457-MH100CL-D	100-W very wide flood	129	4,500	65	NA	6 ¹ / ₄	10 ⁵ / ₈	0–362
Luminaires for ED17 Lamps									
Kramer Lighting Co. ✚	KL8-100MH-ADJ-ND-CFF	100-W coated	125	11,814	14	44	8	10 ⁷ / ₈	0–358
	KL8-100MH-ADJ-ND-CFF	100-W clear	125	46,240	7	61	8	10 ⁷ / ₈	0–358
Kurt Versen	R7480	50-W clear	72	12,180	18	42	8	13 ¹ / ₂	0–360
	R7480	50-W coated	72	3,718	22	28	8	13 ¹ / ₂	0–360
	R7480	70-W clear	94	18,360	18	41	8	13 ¹ / ₂	0–360
	R7480	70-W coated	94	5,249	21	27	8	13 ¹ / ₂	0–360
	✚ R7480	100-W clear	125	28,246	18	41	8	13 ¹ / ₂	0–360
	R7480	100-W coated	125	8,749	22	27	8	13 ¹ / ₂	0–360

NS = not supplied

1 in. = 2.54 cm 1 lb = 0.45 kg

All luminaires in this table have a fixed reflector system.

^a Lamp shields are not required for luminaires that use MH PAR lamps (UL 1990).

^b FA: from above; TA: through aperture.

^c B: black; BB: black baffle; Br: bronze; C: clear; Ch: champagne; CG: charcoal gray; ChG: champagne gold; G: gold; Gr: gray; LG: light gray; P: pewter; S: specular; SGC: soft glow clear; SGP: soft glow pewter; SGW: soft glow wheat; SS: semi-specular; W: wheat. Finish given in bold is standard.

^d SF: self-flanged; TR: trim ring.

^e All luminaires in this table are compatible with sloped ceilings. Contact manufacturer for slope limits.

^f AL: auxiliary lamp; EC: emergency circuit; F: ballast fuse.

^g Luminaires with 6 in. apertures also available with identical characteristics.

Vertical Aiming Range (°)	Lockable Aiming Position	Lamp Shield Type ^a	Aiming Access ^b	Relamping Access ^b	Ballast Access ^b	Weight (lb)	Reflector Cone Finish ^c	Reflector Cone Trim ^d	Sloped Ceiling Adaptor Required ^e	Damp Location Label	Luminaire Options ^f	Labeling
0-45	yes	none	TA	FA/TA	FA/TA	40	B, BB, C , Ch, G, P	SF	no	yes	F	UL, CSA
0-45	yes	none	TA	FA/TA	FA/TA	40	B, BB, C , Ch, G, P	SF	no	yes	F	UL, CSA
0-45	yes	none	TA	FA/TA	FA/TA	40	B, BB, C , Ch, G, P	SF	no	yes	F	UL, CSA
0-45	yes	none	TA	FA/TA	FA/TA	40	B, BB, C , Ch, G, P	SF	no	yes	F	UL, CSA
0-45	yes	none	TA	FA/TA	FA/TA	40	B, BB, C , Ch, G, P	SF	no	yes	F	UL, CSA
0-45	yes	none	TA	FA/TA	FA/TA	40	B, BB, C , Ch, G, P	SF	no	yes	F	UL, CSA
0-25	yes	none	TA	TA	TA	20	C , G	TR	no	no	F	UL
0-25	yes	none	TA	TA	TA	20	C , G	TR	no	no	F	UL
0-25	yes	none	TA	TA	TA	20	C , G	TR	no	no	F	UL
0-25	yes	none	TA	TA	TA	20	C , G	TR	no	no	F	UL
0-25	yes	none	TA	TA	TA	20	C , G	TR	no	no	F	UL
0-25	yes	none	TA	TA	TA	20	C , G	TR	no	no	F	UL
0-30	yes	glass	TA	TA	FA/TA	30	Br, C , CG, ChG, LG	SF	yes	yes	AL, EC, F	UL
0-30	yes	glass	TA	TA	FA/TA	30	Br, C , CG, ChG, LG	SF	yes	yes	AL, EC, F	UL
0-35	yes	glass	FA/TA	FA/TA	TA	24	B, Br, G, P, S , SGC, SGP, SGW, W	SF	no	yes	AL, EC, F	UL
0-35	yes	glass	FA/TA	FA/TA	TA	24	B, Br, G, P, S , SGC, SGP, SGW, W	SF	no	yes	AL, EC, F	UL
0-35	yes	glass	FA/TA	FA/TA	TA	24	B, Br, G, P, S , SGC, SGP, SGW, W	SF	no	yes	AL, EC, F	UL
0-35	yes	glass	FA/TA	FA/TA	TA	24	B, Br, G, P, S , SGC, SGP, SGW, W	SF	no	yes	AL, EC, F	UL
0-35	yes	glass	FA/TA	FA/TA	TA	24	B, Br, G, P, S , SGC, SGP, SGW, W	SF	no	yes	AL, EC, F	UL
0-35	yes	glass	FA/TA	FA/TA	TA	24	B, Br, G, P, S , SGC, SGP, SGW, W	SF	no	yes	AL, EC, F	UL

Table 9. Manufacturer-Supplied Information: Semi-Recessed Adjustable Accent Luminaires for HPS Lamps
(Products marked with ✚ were tested by NLRIP)

a. With Adjustable Reflectors

Manufacturer	Catalog Number	Lamp Type	Active Power (W)	Beam Angle ^a		CBCP ^a		Luminaire Efficiency (%)
				at Max. (°)	at Min. (°)	at Max. (cd)	at Min. (cd)	
Lithonia Lighting	DH 35 SDW 7PD 120	35-W T10 White Son	45	25.4	8.9	NS	NS	90
	DH 50 SDW 7PD 120	50-W T10 White Son	68	25.4	8.9	NS	NS	90
	DH 100 SDW 7PD 120	100-W T10 White Son	120	25.4	8.9	15,600 ^g	83,000 ^g	90

NS = not supplied

1 in. = 2.54 cm 1 lb = 0.45 kg

^a Max.: maximum distribution; Min.: minimum distribution.

^b FA: from above; TA: through aperture.

^c Wh: white. For the luminaires in this table, given finish is standard; no other options were supplied.

^d F: self-flanged.

^e All luminaires in this table are compatible with sloped ceilings. Contact manufacturer for slope limits.

^f F: ballast fuse. None of the luminaires have a lockable aiming position, instant restrike, an auxiliary lamp, or an emergency circuit.

^g The reported distribution is to 50% CBCP.

b. With Interchangeable Reflectors

Manufacturer	Catalog Number	Lamp Type	Active Power (W)	Distributions Available (°)	CBCP (cd)	Beam Angle (°)	Luminaire Efficiency (%)
Indy Lighting	✚ 402R-35	35-W T10 White Son	45	5	42,800	6	56
				12	23,000	10	
				30	2,200	25	
✚ 402R-50	50-W T10 White Son	68	5	78,800	6	56	
			12	42,400	10		
			30	4,100	25		
402R-100	100-W T10 White Son	120	12	73,200	10	56	
			30	8,800	25		

NS = not supplied

1 in. = 2.54 cm 1 lb = 0.45 kg

^a TA: through aperture.

^b Ch: champagne; S: specular. Finish given in bold is standard.

^c TR: trim ring.

^d All luminaires in this table are compatible with sloped ceilings. Contact manufacturer for slope limits.

^e F: ballast fuse. None of the luminaires have a lockable aiming position, instant restrike, an auxiliary lamp, or an emergency circuit.

Aperture Diameter (in.)	Recessed Depth (in.)	Horizontal Rotation Range (°)	Vertical Aiming Range (°)	Aiming Access ^b	Relamping Access ^b	Ballast Access ^b	Weight (lb)	Reflector Cone Finish ^c	Reflector Cone Trim ^d	Sloped Ceiling Adaptor Required ^e	Damp Location Label	Luminaire Options ^f	Labeling
7 ³ / ₈	13 ¹ / ₈	0–355	0–90	TA	TA	FA/TA	45	Wh	SF	no	yes	F	UL, CSA
7 ³ / ₈	13 ¹ / ₈	0–355	0–90	TA	TA	FA/TA	45	Wh	SF	no	yes	F	UL, CSA
7 ³ / ₈	13 ¹ / ₈	0–355	0–90	TA	TA	FA/TA	45	Wh	SF	no	yes	F	UL, CSA

Aperture Size (in.)	Recessed Depth (in.)	Horizontal Rotation Range (°)	Vertical Aiming Range (°)	Aiming Access ^a	Relamping Access ^a	Ballast Access ^a	Weight (lb)	Reflector Cone Finish ^b	Reflector Cone Trim ^c	Sloped Ceiling Adaptor Required ^d	Damp Location Label	Luminaire Options ^e	Labeling
7 ³ / ₈	12	0–355	0–45	TA	TA	TA	10	Ch, S	TR	yes	yes	F	UL, CSA
7 ³ / ₈	12	0–355	0–45	TA	TA	TA	10	Ch, S	TR	yes	yes	F	UL, CSA
7 ³ / ₈	12	0–355	0–45	TA	TA	TA	10	Ch, S	TR	yes	yes	F	UL, CSA

Table 10. Manufacturer-Supplied Information: Semi-Recessed Adjustable Accent Luminaires for MH Lamps

Manufacturer	Catalog Number	Lamp Type	Active Power (W)	Reflector System Type	Distributions Available	CBCP (cd)	Beam Angle (°)	Luminaire Efficiency (%)	Aperture Diameter (in.)	Recessed Depth (in.)
Luminaires for PAR38 Lamps										
Lightolier	PD 7C 70 HE	70-W spot	90	fixed	NA	28,000	20	100	5 ³ / ₄	10 ⁵ / ₈
	PD 7C 70 HE	70-W flood	90	fixed	NA	16,000	35	100	5 ³ / ₄	10 ⁵ / ₈
	PD 7C 70 HE	70-W very wide flood	90	fixed	NA	4,000	65	100	5 ³ / ₄	10 ⁵ / ₈
	PD 7C 10 HE	100-W spot	126	fixed	NA	40,000	20	100	5 ³ / ₄	10 ⁵ / ₈
	PD 7C 10 HE	100-W flood	126	fixed	NA	21,000	35	100	5 ³ / ₄	10 ⁵ / ₈
	PD 7C 10 HE	100-W very wide flood	126	fixed	NA	6,000	65	100	5 ³ / ₄	10 ⁵ / ₈
	AE 8C 70 HD	70-W spot	90	fixed	NA	28,000	20	100	6 ⁹ / ₁₆	9
	AE 8C 70 HD	70-W flood	90	fixed	NA	16,000	35	100	6 ⁹ / ₁₆	9
	AE 8C 70 HD	100-W very wide flood	90	fixed	NA	4,000	65	100	6 ⁹ / ₁₆	9
	AE 8C 10 HD	100-W spot	126	fixed	NA	40,000	20	100	6 ⁹ / ₁₆	9
	AE 8C 100 HD	100-W flood	126	fixed	NA	21,000	35	100	6 ⁹ / ₁₆	9
	AE 8C 100 HD	100-W very wide flood	126	fixed	NA	6,000	65	100	6 ⁹ / ₁₆	9
Miroflector	MHP7PE/70	70-W	70	fixed	NA	NS	20	100	5 ³ / ₈	12 ³ / ₄
	MHP7PE/70	70-W flood	70	fixed	NA	NS	35	100	5 ³ / ₈	12 ³ / ₄
	MHP7PE/70	70-W very wide flood	70	fixed	NA	NS	65	100	5 ³ / ₈	12 ³ / ₄
	MHP7PE/100	100-W	100	fixed	NA	25,896	20	100	5 ³ / ₈	12 ³ / ₄
	MHP7PE/100	100-W flood	100	fixed	NA	11,952	35	100	5 ³ / ₈	12 ³ / ₄
	MHP7PE/100	100-W very wide flood	100	fixed	NA	4,482	65	100	5 ³ / ₈	12 ³ / ₄
Luminaires for T6 Double-Ended Lamps										
Lightolier	SR7 70Q/SR7J WH	70-W	80	intchg.	25	12,275	25	87.6	7 ¹ / ₈	5 ³ / ₈
					26	11,230	26	64.6 ^g		
					38 × 50	4,475	38 × 50	79.8		
Miroflector	Miro-T150	150-W	150	intchg.	NS	97,830	12	NS	12	13
						46,449	17			
						19,431	25			
						11,992	40			
						NS	15 × 54			
	Miro-T 70	70-W	70	intchg.	NS	43,480	12	67.5	12	13
						20,644	17	69.4		
						8,636	25	57.3		
					5,330	40	66.9			
					NS	15 × 54	62.5			
	Miro-T 70 RVF	70-W	70	fixed	NA	2,338	NS	69	7 ⁷ / ₈ × 12 ⁵ / ₈ ^h	14 ¹ / ₄
	Miro-T 100 RVF	100-W	100	fixed	NA	5,260	NS	NS	7 ⁷ / ₈ × 12 ⁵ / ₈ ^h	14 ¹ / ₄

NA = not applicable

NS = not supplied

1 in. = 2.54 cm 1 lb = 0.45 kg

All luminaires in this table are available with a damp location label.

^a Lamp shields are not required for luminaires that use MH PAR lamps (UL 1990).

^b FA: from above; TA: through aperture.

^c BB: black baffle; S: specular; Wh: white.

Horizontal Rotation Range (°)	Vertical Aiming Range (°)	Lockable Aiming Position	Lamp Shield Type ^a	Aiming Access ^b	Relamping Access ^b	Ballast Access ^b	Weight (lb)	Standard Reflector Cone Finish ^c	Standard Reflector Cone Trim ^d	Sloped Ceiling Adaptor Required ^e	Luminaire Options ^f	Labeling
0–358	0–90	no	glass or louver	TA	TA	FA/TA	NS	Wh	SF	no	F	UL, CSA
0–358	0–90	no	glass or louver	TA	TA	FA/TA	NS	Wh	SF	no	F	UL, CSA
0–358	0–90	no	glass or louver	TA	TA	FA/TA	NS	Wh	SF	no	F	UL, CSA
0–358	0–90	no	glass or louver	TA	TA	FA/TA	NS	Wh	SF	no	F	UL, CSA
0–358	0–90	no	glass or louver	TA	TA	FA/TA	NS	Wh	SF	no	F	UL, CSA
0–358	0–90	no	glass or louver	TA	TA	FA/TA	NS	Wh	SF	no	F	UL, CSA
0–358	0–50	no	louver	TA	TA	FA/TA	NS	Wh	SF	no	F	UL, CSA
0–358	0–50	no	louver	TA	TA	FA/TA	NS	Wh	SF	no	F	UL, CSA
0–358	0–50	no	louver	TA	TA	FA/TA	NS	Wh	SF	no	F	UL, CSA
0–358	0–50	no	louver	TA	TA	FA/TA	NS	Wh	SF	no	F	UL, CSA
0–358	0–50	no	louver	TA	TA	FA/TA	NS	Wh	SF	no	F	UL, CSA
0–358	0–50	no	louver	TA	TA	FA/TA	NS	Wh	SF	no	F	UL, CSA
0–358	0–90	yes	glass	TA	TA	NS	NS	Wh	TR	NS	none	UL
0–358	0–90	yes	none	TA	TA	TA	NS	Wh	TR	NS	none	UL
0–358	0–90	yes	none	TA	TA	TA	NS	Wh	TR	NS	none	UL
0–358	0–90	yes	none	TA	TA	TA	NS	Wh	TR	NS	none	UL
0–358	0–90	yes	none	TA	TA	TA	NS	Wh	TR	NS	none	UL
0–358	0–90	yes	none	TA	TA	TA	NS	Wh	TR	NS	none	UL
0–358	0–80	no	glass	TA	TA	FA/TA	NS	Wh	SF	no	none	UL, CSA
0–358	0–90	yes	lens	TA	TA	TA	NS	S	TR	no	EC	UL
0–358	0–90	yes	glass	TA	TA	TA	NS	S	TR	no	EC	UL
none	0–180	yes	tempered glass	TA	TA	NS	NS	BB	SF	NS	none	UL
none	0–180	no	tempered glass	TA	TA	NS	NS	BB	SF	NS	none	UL

^d SF: self-flanged; TR: trim ring.

^e Most luminaires in this table are compatible with sloped ceilings. Contact manufacturer for compatibility and slope limits.

^f EC: emergency circuit; F: ballast fuse. None of the luminaires is available with instant restrike or an auxiliary lamp.

^g The 26° optics has a folded metal lamp shield and thus has a lower efficiency than the 25° and 38° × 50° optics, which do not have shields.

^h This luminaire requires a rectangular aperture.

Table 11. Manufacturer-Supplied Information: Track Luminaires for HPS and MH Lamps
(Products marked with ✚ were tested by NLPPIP)

Manufacturer	Catalog Number	Lamp Type	Active Power (W)	Reflector System Type	Fixed Reflector Systems		Interchangeable Reflector Systems			Track Head Diameter (in.)	
					CBCP (cd)	Beam Angle (°)	Distributions Available (°)	CBCP (cd)	Beam Angle (°)		
Luminaires for HPS Lamps											
Indy Lighting	402T-35	35-W T10 White Son	45	intchg.	NA	NA	5	42,800	6	5 ⁷ / ₈	
							12	23,000	10		
							30	2,200	25		
	402T-50	50-W T10 White Son	68	intchg.	NA	NA	5	78,800	6	5 ⁷ / ₈	
							12	42,400	10		
							30	4,100	25		
	402T-100	100-W T10 White Son	120	intchg.	NA	NA	12	73,200	10	5 ⁷ / ₈	
							30	8,800	25		
							Luminaires for MH PAR38 Lamps				
Indy Lighting	412T-70	70-W	94	fixed	18,000	20	NA	NA	NA	5 ⁷ / ₈	
							NA	NA	NA		
							NA	NA	NA		
	✚	412T-100	100-W	129	fixed	26,000	20	NA	NA	NA	5 ⁷ / ₈
								NA	NA	NA	
								NA	NA	NA	
Staff Lighting	8821-MP070	70-W	89	fixed	18,000	20	NA	NA	NA	6 ¹ / ₈	
							NA	NA	NA		
							NA	NA	NA		
	✚	8821-MP070	70-W	89	fixed	7,000	35	NA	NA	NA	6 ¹ / ₈
								NA	NA	NA	
								NA	NA	NA	
	8821-MP100	100-W	129	fixed	26,000	20	NA	NA	NA	6 ¹ / ₈	
							NA	NA	NA		
							NA	NA	NA		
	8821-MP100	100-W	129	fixed	12,000	35	NA	NA	NA	6 ¹ / ₈	
							NA	NA	NA		
							NA	NA	NA		
Luminaires for MH T6 Double-Ended Lamps											
Capri Lighting	✚ KT5506	70-W	92	fixed	3,480	33 × 75	NA	NA	NA	7 ¹ / ₂ × 5 ³ / ₄	
Lightolier	8290	70-W	80	intchg.	NA	NA	25	12,275	25	7 ¹ / ₈	
	✚ 8291	70-W	80	intchg.	NA	NA	38 × 50	4,475	38 × 50	7 ¹ / ₈	
Miroflector	Miro-T 70 OR	70-W	70	fixed	1,560	NS	NA	NA	NA	NS	
	Miro-T 70 MA	70-W	70	fixed	32,590	NS	NA	NA	NA	NS	
	VE70/TM	70-W	70	fixed	NS	NS	NA	NA	NA	5 ¹ / ₂ × 10	
Luminaires for MH T10 Lamps											
Indy Lighting	✚ 411T-70	70-W	94	intchg.	NA	NA	12.8	45,000	12.8	5 ⁷ / ₈	
							21	15,400	21		
							12.1	34,000	12.1		
							23	12,300	23		

NA = not applicable

NS = not supplied

^a Dimensions = length × width × depth in inches of the luminaire housing.

^b Lamp shields are not required for luminaires that use MH PAR lamps (UL 1990).

^c B: black; Br: bronze; Si: silver; SP: special paint; Wh: white.

^d Pen: pendant; Rec: recessed; Sur: surface.

^e BD: barn doors; CF: color filters; F: ballast fuse; L: louver; MM: monopoint mounting; PM: pendant mounting; SL: spread lens; SOTC: switch on track connector; SS: snoot shield.

Dimensions ^a (l × w × h) (in.)	Horizontal Rotation Range (°)	Vertical Aiming Range (°)	Lockable Aiming Position	Lamp Shield Type ^b	Weight (lb)	Available Stock Finishes ^c	Track Options				Labeling
							Mounting ^d	Circuits	Track Luminaire Options ^e		
7 ¹ / ₈ × 6 ¹ / ₂ × 5 ⁷ / ₈	0–355	0–90	no	none	10	B, SP, Wh	Pen, Rec, Sur	1, 2	BD, MM, PM, SOTC, SS	UL, CSA	
7 ¹ / ₈ × 6 ¹ / ₂ × 5 ⁷ / ₈	0–355	0–90	no	none	10	B, SP, Wh	Pen, Rec, Sur	1, 2	BD, MM, PM, SOTC, SS	UL, CSA	
7 ¹ / ₈ × 6 ¹ / ₂ × 5 ⁷ / ₈	0–355	0–90	no	none	10	B, SP, Wh	Pen, Rec, Sur	1, 2	BD, MM, PM, SOTC, SS	UL, CSA	
7 ¹ / ₈ × 6 ¹ / ₂ × 7 ⁵ / ₈	0–355	0–90	no	none	10	B, SP, Wh	Pen, Rec	1, 2	BD, MM, PM, SOTC, SS	UL, CSA	
7 ¹ / ₈ × 6 ¹ / ₂ × 7 ⁵ / ₈	0–355	0–90	no	none	10	B, SP, Wh	Pen, Rec	1, 2	BD, MM, PM, SOTC, SS	UL, CSA	
7 ¹ / ₈ × 6 ¹ / ₂ × 7 ⁵ / ₈	0–355	0–90	no	none	10	B, SP, Wh	Pen, Rec	1, 2	BD, MM, PM, SOTC, SS	UL, CSA	
7 ¹ / ₈ × 6 ¹ / ₂ × 7 ⁵ / ₈	0–355	0–90	no	none	10	B, SP, Wh	Pen, Rec	1, 2	BD, MM, PM, SOTC, SS	UL, CSA	
7 ¹ / ₈ × 6 ¹ / ₂ × 7 ⁵ / ₈	0–355	0–90	no	none	10	B, SP, Wh	Pen, Rec	1, 2	BD, MM, PM, SOTC, SS	UL, CSA	
7 ¹ / ₈ × 6 ¹ / ₂ × 7 ⁵ / ₈	0–355	0–90	no	none	10	B, SP, Wh	Pen, Rec	1, 2	BD, MM, PM, SOTC, SS	UL, CSA	
10 ¹ / ₂ × 6 ¹ / ₈ × 6 ¹ / ₈	0–362	0–90	no	none	10	B, Br, Si, Wh	Pen, Rec, Sur	1, 3	CF, F, L, MM, SL, SS	UL	
10 ¹ / ₂ × 6 ¹ / ₈ × 6 ¹ / ₈	0–362	0–90	no	none	10	B, Br, Si, Wh	Pen, Rec, Sur	1, 3	CF, F, L, MM, SL, SS	UL	
10 ¹ / ₂ × 6 ¹ / ₈ × 6 ¹ / ₈	0–362	0–90	no	none	10	B, Br, Si, Wh	Pen, Rec, Sur	1, 3	CF, F, L, MM, SL, SS	UL	
10 ¹ / ₂ × 6 ¹ / ₈ × 6 ¹ / ₈	0–362	0–90	no	none	10	B, Br, Si, Wh	Pen, Rec, Sur	1, 3	CF, F, L, MM, SL, SS	UL	
10 ¹ / ₂ × 6 ¹ / ₈ × 6 ¹ / ₈	0–362	0–90	no	none	10	B, Br, Si, Wh	Pen, Rec, Sur	1, 3	CF, F, L, MM, SL, SS	UL	
10 ¹ / ₂ × 6 ¹ / ₈ × 6 ¹ / ₈	0–362	0–90	no	none	10	B, Br, Si, Wh	Pen, Rec, Sur	1, 3	CF, F, L, MM, SL, SS	UL	
11 ³ / ₄ × 7 ¹ / ₂ × 15 ¹ / ₂	0–358	0–90	yes	glass	13	B, Wh	Pen, Rec, Sur	1, 2	PM	UL, CSA	
12 ¹ / ₆ × 8 × 2	0–90	0–180	no	glass	9.55	B, Wh	Pen, Rec, Sur	1, 2	BD, L, PM	UL, CSA	
12 ¹ / ₆ × 8 × 2	0–90	0–180	no	glass	9.55	B, Wh	Pen, Rec, Sur	1, 2	BD, L, PM	UL, CSA	
6 ³ / ₈ × 8 ¹ / ₂ × 3 ¹ / ₄	NS	NS	yes	glass	NS	B, Wh	Pen, Sur	1, 3	BD, CF, L	UL	
7 ¹ / ₂ × 8 ¹ / ₂ × 5	NS	NS	yes	glass	NS	B, Wh	Pen, Sur	1, 3	BD, CF, L	UL	
NS	0–350	0–90	yes	none	NS	NS	Track, Yoke	NS	BD, CF, SL, L	UL	
7 ¹ / ₈ × 6 ¹ / ₂ × 5 ⁷ / ₈	0–355	0–90	no	none	10	B, SP, Wh	Pen, Rec, Sur	1	BD, MM, PM, SOTC, SS	UL, CSA	

Table 12. Manufacturer-Supplied Information: Luminaire Supplement

Manufacturer	Trade Name	Catalog Number ^a	Luminaire Type	Lamp Type
Edison Price	ARCLITE	ARC 38/5AA	Recessed	MH
	ARCLITE	ARC 38/6AA	Recessed	MH
	ARCLITE	ARC 38/7AA	Recessed	MH
Halo	none	L5012	Track	MH
	none	M7854	Semi-Recessed	MH
Kurt Versen	none	R7480	Recessed	MH
	none	R7411	Recessed	MH
Lighting Services Inc.	Metal Halide Spot Light	M2703	Track	MH
	Metal Halide Spot Light	M2803 OR M2807	Track	MH
	Metal Halide Spot Light	M2907 OR M2901	Track	MH
	Metal Halide Cylinder	M1003	Track	MH
	Metal Halide Cylinder	M1103 OR M1107	Track	MH
	Metal Halide Cylinder	M1507 OR M1501	Track	MH
Lightolier	Calculite	AA4N35HEA1/AA4	Recessed	MH
	Calculite	PAA6P30HEA1/AA6	Recessed	MH
	Sof-Tech	8294	Track	MH
	Sof-Tech	8295	Track	MH
	Sof-Tech	8296	Track	MH
	Sof-Tech	8297	Track	MH
Miroflector	Ambassador Series	AM-S/T10	Track	HPS
	Ambassador Series	AM-MH/T10	Track	MH
	Apollo Series	AP-20	Track	MH
	Apollo Series	AP-30	Track	MH
	Apollo Series	AP-38	Track	MH
	MHP7PE Series	MHP7PE	Semi-Recessed	MH
	MHP Series	MHP7RA	Recessed	MH
	Miro-T Vega Flood	Miro-T VFA and VFB	Surface-Mounted	MH
	Miro-T	Miro-T	Pendant	MH
OSRAM SYLVANIA INC.	Metalarc Pro-Tech	MPD100/U/MED/830	NS	MH
	Metalarc Pro-Tech	MPD70/U/MED/830	NS	MH
	Metalarc Pro-Tech	MPD70/PAR30/U/830	NS	MH
	Metalarc Pro-Tech	MPD50/PAR30/U/830	NS	MH

^a Catalog number represents the manufacturer's catalog number for the basic luminaire, without options and without a designated lamp wattage.

Lamp Shape	Available Wattages (W)
PAR38	70, 100, 150
PAR38	70, 100, 150
PAR38	70, 100, 150
PAR38	70, 100
PAR38	70, 100
ED17	50, 70, 100, 150
PAR38	70, 100
PAR20	35
PAR30	35, 70
PAR38	70, 100
PAR20	35
PAR30	35, 70
PAR38	70, 100
PAR20	35
PAR30	35
PAR20	35
PAR30	35
PAR30	70
PAR38	70
T10	35, 50, 100
T10	50, 70
PAR20	35
PAR30	35, 70
PAR38	35, 70, 100, 150
PAR38	70, 100, 150
PAR38	70, 100, 150
T6	70, 150
T6	70, 150
ED17	100
ED17	70
PAR30	70
PAR30	50

Table 13. NLP-Measured Data: Recessed And Semi-Recessed Adjustable Luminaires

Manufacturer	Catalog Number	Lamp Type	Vertical Aiming				
			Ease of Aiming	Aiming Range (°)	Lockable	Ease of Locking	Locking Device
Recessed Adjustable Luminaires for MH Lamps							
Capri Lighting	MHAD 15/100-RMS40	100-W PAR38 MH	difficult ^b	0–27	yes	difficult	hex bolts; have to remove cone
Indy Lighting	426R-100-SAC	100-W PAR38 MH	moderate ^d	0–20	no	NA	NA
Kramer Lighting Co.	KL8 100MH ADJ ND CFF	100-W ED17 coated	easy ^f	0–30	yes	easy	wingnuts
Kurt Versen	R7480-100	100-W ED17 MH	moderate ^h	0–46	yes	easy	wingnuts
Kurt Versen	R7311	100-W ED17 coated	moderate ^f	0–37	yes	easy	wingnuts
Lightolier	AA7CB10HDCL	100-W PAR38 MH	difficult ^j	0–34	no	NA	NA
Staff Lighting	SW/650 120V HSG	100-W PAR38 MH	easy ^f	0–50	yes	easy	thumbscrew
Recessed Adjustable Luminaires for HPS Lamps							
Edison Price	73B7805	50-W T10 White Son	easy ^f	0–44	yes	easy	wingnuts
Indy Lighting	404R-35	35-W T10 White Son	moderate ^d	0–38	no	NA	NA
Indy Lighting	404R-50	50-W T10 White Son	moderate ^d	0–38	no	NA	NA
Kramer Lighting Co.	KL8 100WS E17 ADJ ND CFF	100-W ED17 White Son	easy ^f	0–30	yes	easy	wingnuts
Staff Lighting	684-WS100-CL-1	100-W T10 White Son	moderate ^m	0–34	yes	easy	wingnuts
Semi-Recessed Adjustable Luminaires for HPS Lamps							
Indy Lighting	402-R-50	50-W T10 White Son	easy ^f	0–69	no	NA	NA
	402-R-35	35-W T10 White Son	easy ^f	0–69	no	NA	NA

NA = not applicable

^a UL: label indicating Underwriters Laboratory listing; MAX: label indicating maximum wattage.

^b Had to remove reflector cone to loosen hex bolts before luminaire could be aimed. After bolts were loosened, luminaire was easy to aim.

^c Had to remove the lamp first, then attach the spring to the luminaire.

^d Yoke is supported from one location at the top of the yoke to the luminaire by a rivet. To aim luminaire, yoke had to be rotated around this one support.

^e Tension clips made it easy to install.

^f Yoke moved easily.

Table 14. NLP-Measured Data: Track Luminaires

Manufacturer	Catalog Number	Lamp Type	Vertical Aiming			Horizontal Aiming	
			Ease of Aiming	Range (°)	Lockable	Ease of Rotation	Rotation Range (°)
Capri Lighting	KT 5506 BK	70-W double-ended MH	easy ^b	0–180	yes	easy ^b	0–332
Indy Lighting	411T-70-W	70-W T10 MH	easy ^b	0–90	no	easy ^b	0–341
Indy Lighting	412T-100-W	100-W PAR38 MH	easy ^b	0–90	no	easy ^b	0–335
Lightolier	8291WH	70-W double-ended MH	easy ^b	0–180	no	easy ^b	0–180
Staff Lighting	8821-MP070	70-W PAR38 MH	easy ^b	0–90	no	easy ^b	0–360

NA = not applicable

^a UL: label indicating Underwriters Laboratory listing; MAX: label indicating maximum wattage.

^b Track head moved easily and smoothly.

^c Glass shield is installed in a frame that attaches to the luminaire with thumbscrews.

Horizontal Aiming			Relamping					
Ease of Rotation	Rotation Range (°)	Remove Reflector Cone	Reflector Cone Attached to Luminaire During Relamping	Ease of Reinstalling Reflector Cone	Reflector Cone Attachment Device	Remove Reflector Cone	Remove Protective Glass Cover	Labeling ^a
moderate	0–360	yes		difficult ^c	springs from cone to luminaire	no	none	UL, MAX
moderate	0–351	no	no	easy ^e	tension clips	no	none	UL, MAX
easy	0–350 ^g	yes	yes	easy ^e	tension clips and chain	yes	no	UL, MAX
none	0–360	yes	yes	easy ^e	tension clips and chain	no	yes	UL, MAX
difficult	0–334	no	yes	moderate ⁱ	springs from cone to luminaire	no	none	UL, MAX
difficult	0–360	yes	no	difficult ^k	support clips and chain	no	none	UL, MAX
easy	0–349	no	yes	moderate ^l	springs from cone to luminaire	no	none	UL, MAX
easy	0–356	no	no	moderate ⁱ	springs from cone to luminaire	no	none	none
moderate	0–342	no	no	easy ^e	tension clips	no	none	UL, MAX
moderate	0–345	no	no	easy ^e	tension clips	no	none	UL, MAX
easy	0–350	no	no	easy ^e	tension clips and chain	no	none	MAX
easy	0–360	no	no	easy ^e	tension clips	no	none	none
easy	0–323	no	no	easy ^e	tension clips	no	none	UL, MAX
easy	0–330	no	no	easy ^e	tension clips	no	none	UL, MAX

^g Needed to remove reflector cone chain attachment to achieve full rotation.

^h Needed to remove reflector cone and remove glass shield.

ⁱ Springs made it moderately difficult to install.

^j Difficult to adjust yoke because of a rivet attachment.

^k Yoke is connected to the reflector cone as a unit, which required removal of the unit for relamping.

^l Needed to attach the spring to the luminaire. Trim ring had to be held in place along with the cover to install.

^m Needed to push upper reflector to aim.

Ease of Removing/ Reinstalling Lamp	Remove Protective Glass Cover	Ease of Reinstalling Protective Glass Cover	Reflector Cone Attachment Device	Ease of Attachment to Track	Labeling ^a
difficult	yes	moderate ^c	screw	difficult ^d	UL, MAX
easy	none	NA	tension clips	easy ^e	none
easy	none	NA	no reflector ^f	easy ^e	none
difficult	yes	easy ^g	screw	easy ^e	UL, MAX
easy	none	NA	no reflector cone	easy ^e	UL, MAX

^d Difficult to determine when track connector was seated in track.

^e Connector design was simple and easy to install in track.

^f Black step-baffle glare shield attached with tension clips.

^g Shield held in place with clips, which made it easy to reinstall/remove shield.

NATIONAL LIGHTING PRODUCT INFORMATION PROGRAM

Specifier Reports

HID Accent Lighting Systems

Volume 4, Number 2
October 1996

Principal Investigator: Dorene Maniccia

Technical Editor: Claudia Hunter/
Katherine Miller

Program Director: Robert Davis

Production Manager: James Gross

© 1996 Rensselaer Polytechnic Institute.
All Rights Reserved.

ISSN 1067-2451

The production of this report involved important contributions from many people. J. Walker of Lighting Sciences, Inc. supervised the lamp testing. Lighting Research Center (LRC) staff members also contributed. Q. Wang constructed the luminaire testing apparatus and A. Bierman conducted the lamp-ballast testing. Q. Wang assisted in conducting the luminaire evaluations. J. Barry, E. Gillmeister, V. Schrowang, and T. Zhou compiled the data for the report. A. Fowler and C. Luo assisted in preparing early versions of the manuscript. W. McCandless and J. Teague prepared the graphics. P. Boyce, J. Ceterski, K. Conway, E. Gandorf, K. Heslin, P. Horner, Y. Ji, R. Leslie, N. Miller, M. Rea, and P. Rodgers also contributed. Photography by Robert Benson (Fig. 1) and Donna Abbott Vlahos.

Technical reviews were provided by J. Barron and M. Walton, New York State Energy Research and Development Authority; C. Berrones, CInergy; R. Burkett, Randy Burkett Lighting Design; D. Gibbs, CInergy; R. Hammer, Northern States Power Company; M. Hanson, Energy Center of Wisconsin; M. Hay, Syska & Hennessy; M. Netter, private attorney; N. Olson, Iowa Energy Center; P. Roth, consultant;

M. Tikoff, US Environmental Protection Agency; and D. Toso, Madison Gas and Electric Company. Reviewers are listed to acknowledge their contributions to the final publication. Their approval or endorsement of this report is not necessarily implied.

No portion of this publication or the information contained herein may be duplicated or excerpted in any way in other publications, databases, or any other medium without express written permission of Rensselaer Polytechnic Institute. Making copies of all or part of this publication for any purpose other than for undistributed personal use is a violation of United States copyright laws. It is against the law to inaccurately present information extracted from Specifier Reports for product publicity purposes.

The products described herein have not been tested for safety. The Lighting Research Center and Rensselaer Polytechnic Institute make no representations whatsoever with regard to safety of products, in whatever form or combination used, and the results of testing set forth for your information cannot be regarded as a representation that the products are or are not safe to use in any specific situation, or that the particular product you purchase will conform to the results found in this report.

The National Lighting Product Information Program

The National Lighting Product Information Program (NLPIP) was established in 1990 and is administered by the Lighting Research Center at Rensselaer Polytechnic Institute. The Lighting Research Center is a nonprofit educational and research organization dedicated to the advancement of lighting knowledge.

NLPIP's mission is to rapidly provide the best information available on efficient lighting products. NLPIP strives to provide complete, current, and valuable manufacturer-specific performance data in useful formats to guide lighting decisions. Priority is given to information not available now or not easily accessible from other sources.

The National Lighting Product Information Program tests lighting products according to accepted industry procedures. If procedures are not available or applicable, NLPIP develops interim tests, focusing on those performance issues that are important to the lighting specifier and end user. The program does not accept funding from manufacturers.

Publications:

Guide to Performance Evaluation of Efficient Lighting Products, 1991

Guide to Fluorescent Lamp-Ballast Compatibility, 1996

Guide to Specifying High-Frequency Electronic Ballasts, 1996

Specifier Reports

Power Reducers, 1992; Specular Reflectors, 1992; Occupancy Sensors, 1992;

Parking Lot Luminaires, 1993; Screwbase Compact Fluorescent Lamp

Products, 1993; Cathode-Disconnect Ballasts, 1993; Exit Signs, 1994;

Electronic Ballasts, 1994; Reflector Lamps, 1994; CFL Downlights, 1995;

Dimming Electronic Ballasts, 1995

Specifier Reports Supplements

Screwbase Compact Fluorescent Lamp Products, 1994, 1995; Exit Signs, 1995;

Electronic Ballasts, 1995, 1996

Lighting Answers

T8 Fluorescent Lamps, 1993; Multilayer Polarizer Panels, 1993; Task Lighting

for Offices, 1994; Dimming Systems for High-Intensity Discharge Lamps, 1994;

Electromagnetic Interference Involving Fluorescent Lighting Systems, 1995;

Power Quality, 1995; Thermal Effects in 2'x4' Fluorescent Lighting Systems,

1995; T10 and T9 Fluorescent Lamps, 1995; T5FT Lamps and Ballasts, 1996

For publications ordering information, contact:

Lighting Research Center
Rensselaer Polytechnic Institute
Troy, NY 12180-3590
Phone: (518) 276-8716
Fax: (518) 276-2999
Internet e-mail: lrc@rpi.edu
World Wide Web:
<http://www.lrc.rpi.edu/>

LRC

Lighting Research Center

Rensselaer



50%
TOTAL RECYCLED FIBER
15% POST-CONSUMER FIBER

Specifier Reports

Supplements

The National Lighting Product Information Program (NLPIP) continues its efforts to bring specifiers the most up-to-date product information with this first supplement to Specifier Reports: HID Accent Lighting Systems, originally published in October 1996 and revised in March 1998. This supplement contains information on recessed and semi-recessed adjustable luminaires and track luminaires for metal halide (MH) parabolic aluminized reflector (PAR) 20 and 30 lamps. The tables in this supplement contain product information supplied by the manufacturers, information gathered from manufacturers' literature, and the results of luminaire evaluations conducted by NLPIP.

Manufacturers that submitted sample products to NLPIP by July 31, 1999, are included. These manufacturers were asked to submit product information to NLPIP by November 15, 1999. Edison Price Lighting, Lithonia Lighting, and Prescolite submitted the requested information; product information for all other manufacturers was gathered from their literature.

NLPIP performed luminaire evaluations during October 1999 at the Lighting Research Center's laboratory in Watervliet, New York. NLPIP evaluated one sample of each luminaire submitted by the manufacturers. The evaluation procedure was identical to the procedure in the October 1996 publication, and the table formats are similar.

For information regarding the applications of HID accent lighting systems and an explanation of the terms used in the tables, see the previous section of this document: *Specifier Reports: HID Accent Lighting Systems*.

Tables in this supplement:

Manufacturer-Supplied Information

Table 1. Recessed Adjustable Luminaires for MH PAR Lamps

Table 2. Semi-Recessed Adjustable Luminaires for MH PAR Lamps

Table 3. Track Luminaires for MH PAR Lamps

NLPIP-Measured Data

Table 4. Recessed Adjustable Luminaires for MH PAR Lamps

Table 5. Semi-Recessed Adjustable Luminaires for MH PAR Lamps

Table 6. Track Luminaires for MH PAR Lamps

Manufacturer Contact Information

Table 7. Manufacturer Contact Information

Table 1. Manufacturer-Supplied Information: Recessed Adjustable Luminaires for MH PAR Lamps

Manufacturer	Catalog Number	Lamp Type	Active Power (W)	CBCP (cd)	Beam Angle (°)	Luminaire Efficiency (%)	Aperture Diameter (in.)	Recessed Depth (in.)	Horizontal Rotation Range (°)
Day-Brite Capri Omega	C3856-3812TC	35W PAR30 FL	55	7,896	30	NS	5 ⁵ / ₈	11 ¹ / ₄	0–360
	C3856-3812TC	35W PAR30 SP	55	27,672	10	NS	5 ⁵ / ₈	11 ¹ / ₄	0–360
Edison Price Lighting	ARCLITE 20/4AA	35W PAR20 FL	44	5,537	NS	80.8	4	8	0–358
	ARCLITE 20/4AA	35W PAR20 SP	44	20,431	NS	77.5	4	8	0–358
	ARCLITE 20/5AA	35W PAR20 FL	44	5,374	NS	90.7	5	8	0–358
	ARCLITE 20/5AA	35W PAR20 SP	44	16,854	NS	88.6	5	8	0–358
	ARCLITE 30/5AA	35W PAR30 FL	44	NS	NS	NS	5	9 ³ / ₄	0–358
	ARCLITE 30/5AA	35W PAR30 SP	44	NS	NS	NS	5	9 ³ / ₄	0–358
	ARCLITE 30/5AA	70W PAR30 FL	78	7,327	NS	76.5	5	9 ³ / ₄	0–358
	ARCLITE 30/5AA	70W PAR30 SP	78	44,960	NS	82.9	5	9 ³ / ₄	0–358
	ARCLITE 30/6AA	35W PAR30 FL	44	NS	NS	NS	6	9 ³ / ₄	0–358
	ARCLITE 30/6AA	35W PAR30 SP	44	NS	NS	NS	6	9 ³ / ₄	0–358
	ARCLITE 30/6AA	70W PAR30 FL	78	7,354	NS	82.1	6	9 ³ / ₄	0–358
	ARCLITE 30/6AA	70W PAR30 SP	78	45,667	NS	84.1	6	9 ³ / ₄	0–358
Kurt Versen	R7408	35W PAR20 FL	NS	6,000	30	NS	4 ¹ / ₈	8 ¹³ / ₁₆	0–360
	R7408	35W PAR20 SP	NS	28,000	10	NS	4 ¹ / ₈	8 ¹³ / ₁₆	0–360
Lightolier	AA4P35-HD	35W PAR20 FL	NS	5,000	30	NS	4 ¹ / ₂	7 ¹ / ₄	NS
	AA4P35-HD	35W PAR20 SP	NS	28,000	10	NS	4 ¹ / ₂	7 ¹ / ₄	NS
Lithonia Lighting ^g	DH35MHC-4AC	35W PAR20 SP	NS	28,000	10	NS	4 ⁵ / ₁₆	9	0–355
	DH35MHC-5AC	35W PAR30 SP	NS	28,000	10	NS	5 ¹ / ₁₆	10 ¹ / ₈	0–355
	DH35MHL-5PD	35W PAR20 SP	NS	NS	NS	NS	5 ¹ / ₁₆	13 ¹ / ₄	0–355
Zumtobel Staff Lighting	RML 14245	2 x 35W PAR30	90	NS	NS	NS	7 × 14	8	0–24

NS = not supplied

1 in. = 2.54 cm 1 lb = 0.45 kg

All luminaires in this table have a fixed reflector system.

^a FA: from above; TA: through aperture.

^b B: black; Br: bronze; C: clear; ChG: champagne gold; CS: clear specular; HS: highly specular; P: pewter; S: specular; SD: semi-diffuse; SS: semi-specular; SSC: semi-specular clear; SSG: semi-specular gold.

^c SF: self-flanged.

^d Contact manufacturer for slope limits.

^e AL: auxiliary lamp; EB: electronic ballast; F: ballast fuse.

^f CSA: Canadian Standards Association; IBEW: International Brotherhood of Electrical Workers; UL: Underwriters Laboratory.

^g Manufacturer supplies bar hangers and full vertical adjustment system.

^h Customer has the option to paint SF in white.

Vertical Aiming Range (°)	Lockable Aiming Position	Aiming Access ^a	Relamping Access ^a	Ballast Access ^a	Weight (lb)	Reflector Cone Finish ^b	Reflector Cone Trim ^c	Sloped Ceiling Adaptor Required ^d	Damp Location Label	Luminaire Options ^e	Labeling ^f
0-45	vertical only	TA	TA	FA	NS	Br,ChG,P,SSC,SSG	SF	NS	yes	F	IBEW,UL
0-45	vertical only	TA	TA	FA	NS	Br,ChG,P,SSC,SSG	SF	NS	yes	F	IBEW,UL
0-45	yes	TA	TA	TA	13.5	B,C,ChG,SS	SF	yes	yes	no	UL
0-45	yes	TA	TA	TA	13.5	B,C,ChG,SS	SF	yes	yes	no	UL
0-45	yes	TA	TA	TA	13.5	B,C,ChG,SS	SF	yes	yes	no	UL
0-45	yes	TA	TA	TA	13.5	B,C,ChG,SS	SF	yes	yes	no	UL
0-45	yes	TA	TA	TA	13.5	B,C,ChG,SS	SF	yes	yes	no	UL
0-45	yes	TA	TA	TA	13.5	B,C,ChG,SS	SF	yes	yes	no	UL
0-45	yes	TA	TA	TA	13.5	B,C,ChG,SS	SF	yes	yes	no	UL
0-45	yes	TA	TA	TA	13.5	B,C,ChG,SS	SF	yes	yes	no	UL
0-45	yes	TA	TA	TA	13.5	B,C,ChG,SS	SF	yes	yes	no	UL
0-45	yes	TA	TA	TA	13.5	B,C,ChG,SS	SF	yes	yes	no	UL
0-45	yes	TA	TA	TA	13.5	B,C,ChG,SS	SF	yes	yes	no	UL
0-45	NS	NS	NS	NS	NS	CS	SF	NS	NS	NS	NS
0-45	NS	NS	NS	NS	NS	CS	SF	NS	NS	NS	NS
0-35	NS	NS	NS	side	NS	NS	SF	NS	NS	EB	NS
0-35	NS	NS	NS	side	NS	NS	SF	NS	NS	EB	NS
0-45	yes	TA	TA	side	20.5	HS,S,SD	SF ^h	NS	yes	AL,F	CSA,UL
0-35	yes	TA	TA	side	23.5	HS,S,SD	SF ^h	NS	yes	AL,F	CSA,UL
0-90	NS	NS	NS	side	27.0	NS	SF ^h	NS	yes	NS	NS
0-24	no	TA	TA	TA	15.5	B,Wh,T	Wh	no	NS	none	NS

Table 2. Manufacturer-Supplied Information: Semi-Recessed Adjustable Luminaires for MH PAR Lamps

Manufacturer	Catalog Number	Lamp Type	Active Power (W)	CBCP (cd)	Beam Angle (°)	Luminaire Efficiency (%)	Aperture Diameter (in.)	Recessed Depth (in.)	Horizontal Rotation Range (°)	Vertical Aiming Range (°)
Lightolier	SRP30MH	70W PAR30 FL	NS	7,000	40	NS	6	NS	0–358	0–45
	SRP30MH	70W PAR30 SP	NS	48,000	10	NS	6	NS	0–358	0–45

NS = not supplied

1 in. = 2.54 cm 1 lb = 0.45 kg

All luminaires in this table have a fixed reflector system.

^a FA: from above; TA: through aperture.

^b B: black; T: titan (matte silver); Wh: white.

^c Wh: white.

^d Contact manufacturer for slope limits.

Lockable Aiming Position	Aiming Access ^a	Relamping Access ^a	Ballast Access ^a	Weight (lb)	Reflector Cone Finish ^b	Reflector Cone Trim ^c	Sloped Ceiling Adaptor Required ^d	Luminaire Options	Labeling
no	TA	TA	FA	NS	NS	Wh	no	NS	NS
no	TA	TA	FA	NS	NS	Wh	no	NS	NS

Table 3. Manufacturer-Supplied Information: Track Luminaires for MH PAR Lamps

Manufacturer	Catalog Number	Lamp Type	Active Power (W)	Reflector System Type	Fixed Reflector Systems		Interchangeable Reflector Systems			Track Head Diameter (in.)
					CBCP (cd)	Beam Angle (°)	Distributions Available (°)	CBCP (cd)	Beam Angle (°)	
Lightolier	8294WH	35W PAR20	56	NS	NS	NS	NS	NS	NS	3 ^{1/4}
Lithonia Lighting	TEH35MHC	35W PAR20	NS	NS	NS	NS	NS	NS	NS	NS
Prescolite	TMH35-30L1	35W PAR30 FL	44	NS	4,500	30	NS	NS	NS	3
	TMH35-30L1	35W PAR30 SP	44	NS	42,000	10	NS	NS	NS	3
Zumtobel Staff Lighting	9031	35W PAR30	NS	NS	NS	NS	NS	NS	NS	NS

NS = not supplied

1 in. = 2.54 cm 1 lb = 0.45 kg

^a Dimensions = length x width x depth in inches of the luminaire housing.

^b Lamp shields are not required for luminaires that use MH PAR lamps (UL 1990).

^c B: black; DG: dark gray; Wh: white.

^d BE: beam elongator; BS: beam smoother; CF: color filters; L: louver; LE: lens.

^e CSA: Canadian Standards Association; IBEW: International Brotherhood of Electrical Workers; UL: Underwriters Laboratory.

Dimensions ^a (l × w × h) (in.)	Horizontal Rotation Range (°)	Vertical Aiming Range (°)	Lockable Aiming Position	Lamp Shield Type ^b	Weight (lb)	Available Stock Finishes ^c	Track Options		Track Luminaire Options ^d	Labeling ^e
							Mounting	Circuits		
7 × 4 ¹ / ₂ × 4 ¹ / ₂	0–180	0–180	yes	NS	NS	B,Wh	NS	NS	BE,BS,L	IBEW,UL
6 ³ / ₄ × 8 ¹ / ₄ × 4 ¹ / ₂	0–330	0–90	yes	sliding lamp holder	NS	B,Wh	NS	NS	CF	CSA,UL
8 ³ / ₄ × 4 ⁷ / ₈ × 10	0–358	0–85	yes	NS	NS	DG,Wh	NS	1, 2	CF,LE	CSA,UL
8 ³ / ₄ × 4 ⁷ / ₈ × 10	0–358	0–85	yes	NS	NS	DG,Wh	NS	1, 2	CF,LE	CSA,UL
NS	0–360	0–90	yes	NS	NS	B,Wh	NS	1, 3	NS	IBEW,UL

Table 4. NLPIP-Measured Data: Recessed Adjustable Luminaires for MH PAR Lamps

Vertical Aiming							
Manufacturer	Catalog Number	Lamp Type	Ease of Aiming	Aiming Range (°)	Lockable	Ease of Locking	Locking Device
Day-Brite Capri Omega	C3856-3812TC	35W PAR20 & 30	moderate ^b	0–40	yes	easy	wing nut
Edison Price Lighting	ARCLITE 20/4AA	35W PAR20	moderate ^e	0–45	yes	moderate ^e	wing nut
	ARCLITE 30/5AA	35 & 70W PAR30	difficult ^h	0–45	yes	moderate ^e	wing nut
	ARCLITE 30/6AA	35 & 70W PAR30	easy ^c	0–35	yes	moderate ^e	wing nut
Kurt Versen	R7408 (3512MH)	35W PAR20	difficult ^h	0–45	yes	moderate ^e	wing nut
Lightolier	AA4P35-HD	35W PAR20	moderate ^h	0–30	no	NA	NA
Lithonia Lighting	DH35M-4AC (120 HSG LP Q91)	35W PAR20	easy ^c	0–40	yes	moderate ^e	wing nut
	DH35M-5AC (120 HSG LP Q91)	35W PAR30	easy ^c	0–35	yes	easy	wing nut
	DH35M-5PD (120 LP Q91)	35W PAR20	moderate ⁱ	0–180	no	NA	NA
Zumtobel Staff Lighting	RML14245 (TWH)	2 x 35W PAR30	easy ^c	0–35	no	NA	NA

NA = not applicable

^a UL: Underwriters Laboratory; MAX: maximum wattage.

^b Yoke moves horizontally when trying to aim vertically.

^c Socket moved easily and smoothly.

^d Socket wire does not allow the yoke to go any farther.

^e Wing nut was difficult to reach.

^f Had to remove reflector cone to loosen wing nuts before luminaire could be aimed.

^g It is not necessary, but relamping is easier if reflector cone is removed.

^h Socket seemed stuck.

ⁱ Socket position is too deep in luminaire; pull-down mechanism does not move smoothly.

^j Two lamps in the same luminaire limit horizontal rotation range.

Horizontal Aiming			Relamping					
Ease of Rotation	Rotation Range (°)	Remove Reflector Cone	Reflector Cone Attached to Luminaire During Relamping	Ease of Reinstalling Reflector Cone	Reflector Cone Attachment Device	Remove Reflector Cone	Remove Protective Glass Cover	Labeling ^a
easy ^c	0–340 ^d	yes	no	easy	spring lock	yes	NA	UL,MAX
difficult ^f	0–358	yes	no	easy	spring lock	no ^g	NA	UL,MAX
difficult ^f	0–360	yes	no	easy	spring lock, metal strip	yes	NA	UL,MAX
difficult ^f	0–358	yes	no	easy	spring lock	no	NA	UL,MAX
easy ^c	0–360	yes	no	easy	metal strip	yes	NA	UL,MAX
moderate ^h	0–360	no	yes	moderate	tension clips	no ^g	NA	UL,MAX
easy ^c	0–330	yes	yes	easy	ball chain	yes	NA	UL,MAX
easy ^c	0–360	yes	yes	easy	ball chain	yes	NA	UL,MAX
moderate ⁱ	0–355	no	yes	moderate	tension clips	no ^g	NA	UL,MAX
easy ^c	0–150 ^j	NA	no (louvers)	easy	thumb screw	yes (louvers)	NA	UL,MAX

Table 5. NLPIP-Measured Data: Semi-Recessed Adjustable Luminaires for MH PAR Lamps

Manufacturer	Catalog Number	Lamp Type	Ease of Aiming	Vertical Aiming			
				Aiming Range (°)	Lockable	Ease of Locking	Locking Device
Lightolier	SRP30MH	70W PAR30	easy ^b	0–45	no	NA	NA

NA = not applicable

^a UL: Underwriters Laboratory; MAX: maximum wattage.

^b Socket moved easily and smoothly.

Horizontal Aiming			Relamping					
Ease of Rotation	Rotation Range (°)	Remove Reflector Cone	Reflector Cone Attached to Luminaire During Relamping	Ease of Reinstalling Reflector Cone	Reflector Cone Attachment Device	Remove Reflector Cone	Remove Protective Glass Cover	Labeling ⁹
easy ^b	0–358	NA	NA	easy	NA	NA	NA	UL,MAX

Table 6. NLPIP-Measured Data: Track Luminaires for MH PAR Lamps

Vertical Aiming					
Manufacturer	Catalog Number	Lamp Type	Ease of Aiming	Range (°)	Lockable
Lightolier	8294WH	35W PAR20	easy ^b	0–180	no
Lithonia Lighting	TEH35MHC	35W PAR20	easy ^b	0–135	no
Prescolite	TMH35-30L1 (1-B1)	35W PAR30	easy ^b	0–188	no
Zumtobel Staff Lighting	9031	35W PAR30	easy ^b	0–100	yes ^d

^a UL: Underwriters Laboratory; MAX: maximum wattage.

^b Track head moved easily and smoothly.

^c Some strength was required to rotate the luminaires horizontally.

^d Locking device did not lock the luminaire very well.

^e Lamp aperture too small.

Horizontal Aiming

Ease of Rotation	Rotation Range (°)	Ease of Removing/ Reinstalling Lamp	Ease of Attachment to Track	Labeling ^a
difficult ^c	0–300	easy	easy	UL,MAX
easy ^b	0–345	moderate ^e	easy	UL,MAX
difficult ^c	0–360	moderate ^e	moderate	UL,MAX
easy ^b	0–360	easy	easy	UL,MAX

Table 7. Manufacturer Contact Information

Manufacturer	Telephone Number	Fax Number	Web Site
Day-Brite Capri Omega	662-842-7212	662-680-6619	www.thomasc-i.com/omega
Edison Price Lighting	212-521-6900	212-888-7981	NA
Kurt Versen	201-664-8200	201-664-4801	www.kurtversen.com
Lightolier	508-679-8131	508-674-4710	www.lightolier.com
Lithonia Lighting	317-362-1837	317-364-9194	www.lithonia.com
Prescolite, Inc.	510-562-3500	510-577-5069	www.prescolite.com
Zumtobel Staff Lighting	800-932-0633	914-691-6289	www.zumtobel.co.at

NA = not available